

vtech®

User's manual

www.vtechphones.com



Models:

DS6511/DS6511-15/
DS6511-16/DS6511-2/
DS6511-3/DS6511-4A

 **Bluetooth®**



DECT 6.0

Congratulations

on purchasing your new VTech product. Before using this telephone, please read **Important safety instructions** on page 64 of this manual.

This manual has all the feature operations and troubleshooting necessary to install and operate your new VTech telephone. Please review this manual thoroughly to ensure proper installation and operation of this innovative and feature rich VTech product. For support, shopping, and everything new at VTech, visit our website at www.vtechphones.com. In Canada, please visit www.vtechcanada.com.



Telephones identified with this logo have reduced noise and interference when used with most T-coil equipped hearing aids and cochlear implants. The TIA-1083 Compliant Logo is a trademark of the Telecommunications Industry Association. Used under license.

Register online to get an additional 3-month warranty!
Visit www.vtechphones.com.



Registration

Register your product online for enhanced warranty support.



Product news

Learn about the latest VTech products.

The *Bluetooth*[®] word mark and logos are owned by Bluetooth SIG, Inc. and any use of such marks by VTech Holdings Limited is under license. VTech Holdings Limited is a member of Bluetooth SIG, Inc. Other trademarks and trade names are those of their respective owners.

Table of contents

Getting started	1
Parts checklist	1
Telephone base and charger installation	2
Handset battery installation.....	3
Handset battery charging	4
Installation options	5
Tabletop to wall mount installation	5
Wall mount to tabletop installation	7
Are you a new cable or VoIP subscriber?	8
Did you subscribe to voicemail service from your telephone service provider?	8
Telephone base layout	9
Handset layout	10
Bluetooth	12
Introducing Bluetooth	12
Glossary of terms	14
Bluetooth setup	15
Add a cell phone	15
Auto connection	16
Connect a paired cell phone	16
Disconnect a paired cell phone.....	16
Review the cell devices list	16
Download directory	17
Telephone settings	18
Using the menu	18
Ringer volume	19
Ringer tone.....	19
Quiet mode.....	20
Set date and time	21
LCD language	22
Voicemail number.....	22
Clear voicemail indicators	23
Key tone	24
Home area code.....	24
Dial mode	25
Website	25
Telephone operation	26
Make a home call	26
Redial a home call.....	26

Answer a home call.....	26
End a home call	26
Call waiting on the home line	26
Make a cell call.....	27
Redial a cell call	27
Answer a cell call	27
End a cell call	28
Call waiting on the cell line	28
Answer a cell call while on a home call.....	28
Cell phone voicemail	28
Answer a home call while on a cell call	28
Speakerphone	29
Volume control.....	29
Mute	29
Redial	30
Temporary ringer silencing	30
Chain dialing.....	31
Temporary tone dialing.....	31
Find handset.....	32
Multiple handset use	33
Join a call in progress	33
Transfer a call.....	33
Intercom	34
Answer an incoming call during an intercom call.....	34
Directory	35
About the directory	35
Add a directory entry	36
Review directory entries.....	38
Alphabetical search.....	38
Dial a directory entry	39
Edit a directory entry	39
Delete a directory entry.....	40
Delete all contacts.....	40
Speed Dial.....	41
Assign a speed dial entry	41
Reassign a speed dial entry.....	41
Dial a speed dial entry.....	42
Delete a speed dial entry	42

Table of contents

Caller ID	43
About caller ID	43
Information about caller ID with call waiting	43
Caller ID log.....	44
Memory match.....	44
Missed call indicator.....	45
Review the caller ID log	45
View dialing options	46
Dial a caller ID log entry	47
Save a caller ID log entry to the directory	47
Delete caller ID log entries	48
Caller ID log screen messages	48
Appendix	49
Screen messages	49
Handset and telephone base indicators.....	51
Expand your telephone system.....	53
Troubleshooting.....	54
Important safety instructions	63
Battery	64
Precautions for users of implanted cardiac pacemakers.....	64
Operating range	64
ECO mode.....	64
Maintenance.....	65
About cordless telephones.....	65
The RBRC® seal.....	66
FCC, ACTA and IC regulations	67
California Energy Commission battery charging testing instructions.....	69
For C-UL compliance only.....	70
Limited warranty	73
Technical specifications.....	75
Index	76

Getting started

Parts checklist

Your telephone package contains the following items. Save your sales receipt and original packaging in case it is necessary to ship your telephone for warranty service.



Battery compartment cover
(1 for DS6511/DS6511-15/
DS6511-16)
(2 for DS6511-2)
(3 for DS6511-3)
(4 for DS6511-4A)



Battery
(1 for DS6511/DS6511-15/
DS6511-16)
(2 for DS6511-2)
(3 for DS6511-3)
(4 for DS6511-4A)



Handset
(1 for DS6511/DS6511-15/
DS6511-16)
(2 for DS6511-2)
(3 for DS6511-3)
(4 for DS6511-4A)

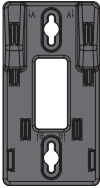

Wall mount bracket



Telephone line cord

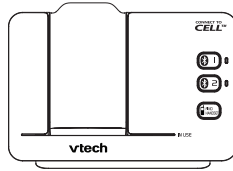

Telephone base

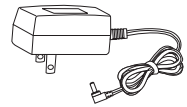

Telephone base adapter

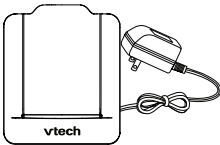

Charger and charger adapter
(1 for DS6511-2)
(2 for DS6511-3)
(3 for DS6511-4A)

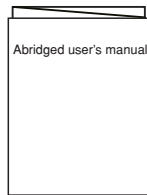

Abridged user's manual

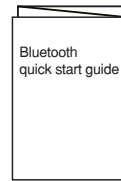

Bluetooth quick start guide

note

To purchase replacement batteries or power adapters, visit our website at www.vtechphones.com or call 1 (800) 595-9511. In Canada, go to www.vtechcanada.com or dial 1 (800) 267-7377.

Getting started

Telephone base and charger installation

Install the telephone base and handset charger(s) as shown below.

Make sure that the electrical outlet is not controlled by a wall switch.

If you subscribe to digital subscriber line (DSL) high-speed Internet service through your telephone line, you must install a DSL filter between the telephone line cord and the telephone wall jack. The filter prevents noise and caller ID problems caused by DSL interference. Contact your DSL service provider for more information about DSL filters.

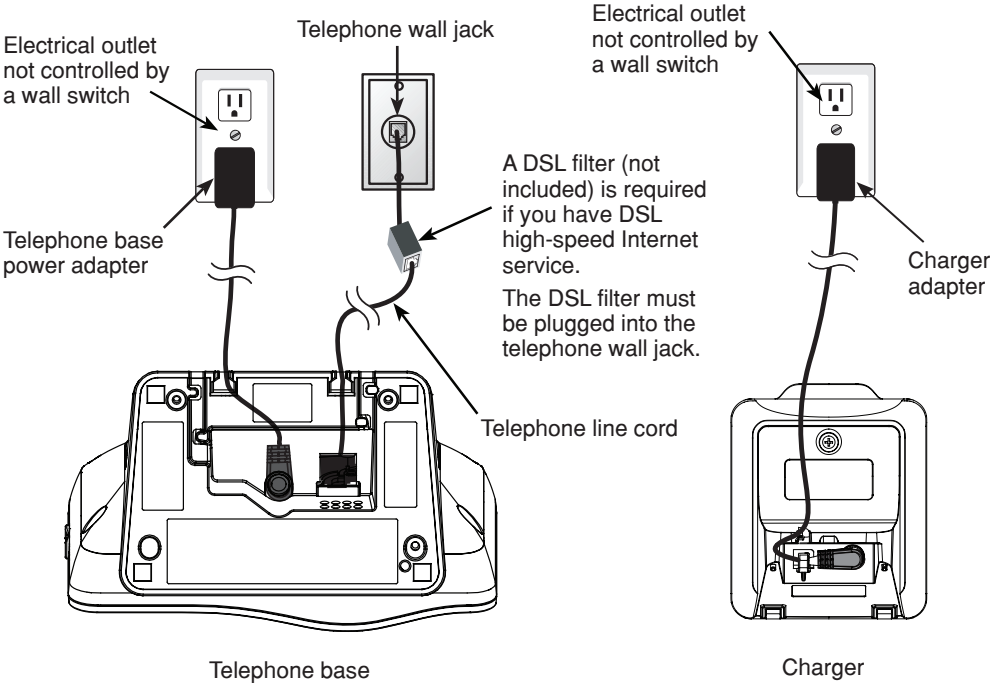

note

Even if you do not subscribe to any conventional telephone service, you can still use the cell line alone without plugging in a telephone line cord.

CAUTION:

If you subscribe to telephone service from a cable company or a VoIP service provider, contact your cable/VoIP service provider for more information.

Getting started

Handset battery installation

Install the battery as shown below.

1. Plug the battery connector securely into the socket inside the handset battery compartment, matching the orientation of the engraved label.

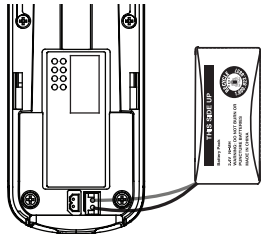

2. Place the battery with the label **THIS SIDE UP** facing up and the wires inside the battery compartment.



3. Align the cover flat against the battery compartment, then slide it towards the center of the handset until it clicks into place.

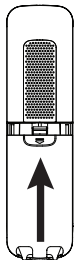

4. Charge the handset by placing it in the telephone base or handset charger. The **CHARGE** light is on when the handset is charging.

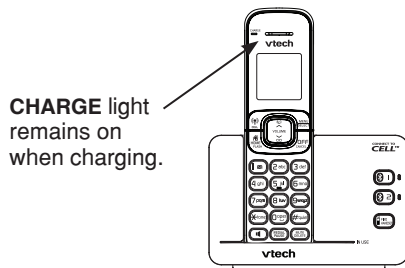

note

- If the handset will not be used for a long time, disconnect and remove the battery to prevent possible leakage.
- To purchase replacement batteries, visit our website at www.vtechphones.com or call 1 (800) 595-9511. In Canada, go to www.vtechcanada.com or dial 1 (800) 267-7377.

IMPORTANT:

Check for a dial tone by pressing **Ⓗ/HOME**. If you hear a dial tone, the installation is successful.

If you do not hear a dial tone:

- Make sure the installation procedures described above are properly done.
- It may be a wiring problem. If you have changed your telephone service to digital service from a cable company or a VoIP service provider, the telephone line may need to be rewired to allow all existing telephone jacks to work. Contact your cable/VoIP service provider for more information.

Getting started

Handset battery charging

Once you have installed the battery, the screen indicates the battery status (see the following table).

note

- For best performance, keep the handset in the telephone base or handset charger when not in use.
- The battery is fully charged after 12 hours of continuous charging.
- If you place the handset in the telephone base or handset charger without installing a battery, the screen displays **NO BATTERY**.

Battery indicators	Battery status	Action
The screen is blank, or displays Put in charger and [] flashes.	The battery has no or very little charge. The handset cannot be used.	Charge without interruption (about 30 minutes).
The screen displays Low battery and [] flashes.	The battery has enough charge to be used for a short time.	Charge without interruption (about 30 minutes).
The screen displays HANDSET X .	The battery is charged.	To keep the battery charged, place it in the telephone base or handset charger when not in use.

When it is fully charged, you can expect the following performance:

Operation	Operating time
While in handset use (talking*)	Up to seven hours
While in speakerphone mode (talking*)	Up to three hours
While not in use (standby**)	Up to five days

* Operating times vary depending on your actual use and the age of the battery.

** Handset is not charging or in use.

After you install your telephone or power returns following a power outage, the handset will prompt you to set the date and time. For instructions, see **Set date and time** on page 21.

To skip setting, press **CANCEL**.

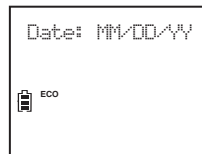

Getting started

Installation options

Your telephone base is ready for tabletop use. If you want to mount your telephone on a wall, use the provided wall mount bracket to connect with a standard dual-stud telephone wall mounting plate. If you do not have this mounting plate, you can purchase one from many hardware or consumer electronics retailers. You may need a professional to install the mounting plate.

Tabletop to wall mount installation

1. If you have already installed the telephone for tabletop use, unplug the telephone line cord from the telephone wall jack, and unplug the telephone base power adapter from the wall outlet. Remove the telephone line cord and the power adapter cord from the grooves.

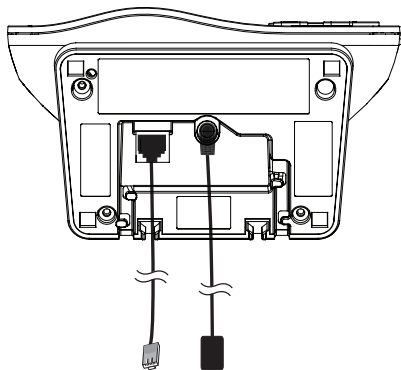

2. Route the telephone line cord through the rectangular hole on the wall mount bracket and plug it into the telephone wall jack. Route the power cord out of the telephone base and plug it into an electrical outlet not controlled by a wall switch.

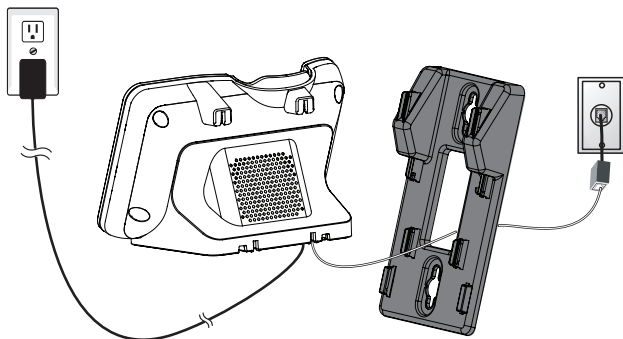

Getting started

Tabletop to wall mount installation

3. Position the lower portion grooves on the telephone base to the lower portion tabs (marked **B**) on the wall mount bracket. Make sure the upper portion grooves of the telephone base are above the upper portion tabs (marked **A**) on the wall mount bracket. Push the telephone base down until it clicks securely in place.

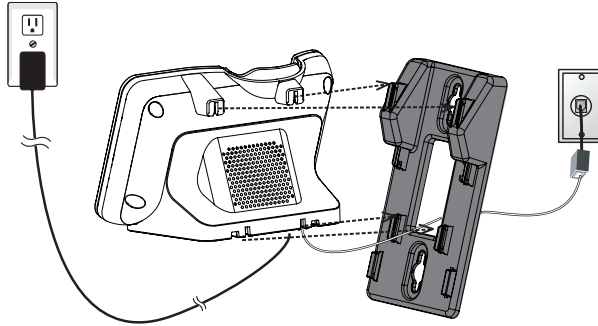

4. Align the holes on the bracket with the standard wall plate and slide the bracket down until it locks securely. Bundle the telephone line cord and power adapter cord neatly with twist ties.

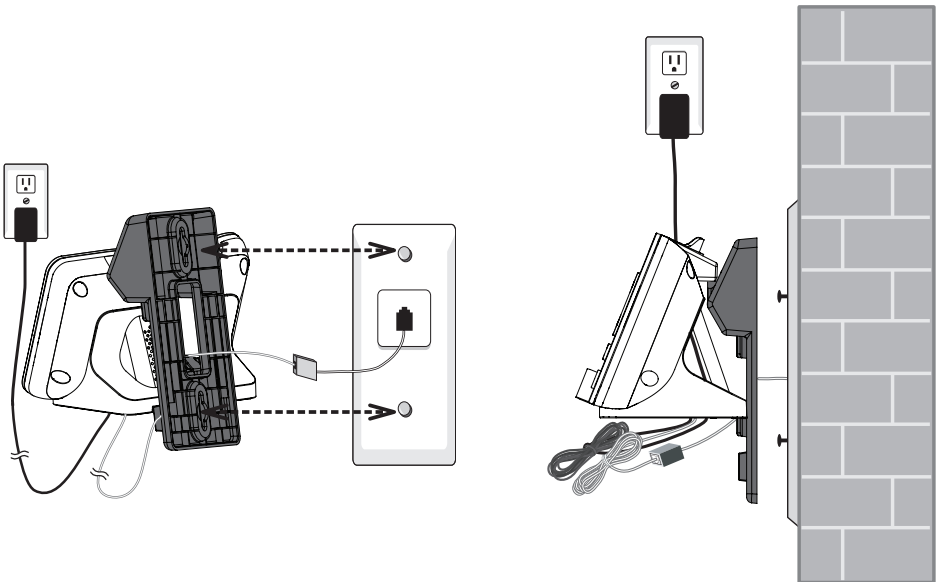

Getting started

Wall mount to tabletop installation

1. If the telephone line cord and power adapter cord are bundled, untie them first.
2. Slide the wall mount bracket up and remove it from the wall plate. Unplug the telephone line cord (or DSL filter) from the wall. Unplug the power adapter from the power outlet.
3. Slide the telephone base up and remove it from the wall mount bracket.
4. See **Telephone base and charger installation** on page 2.

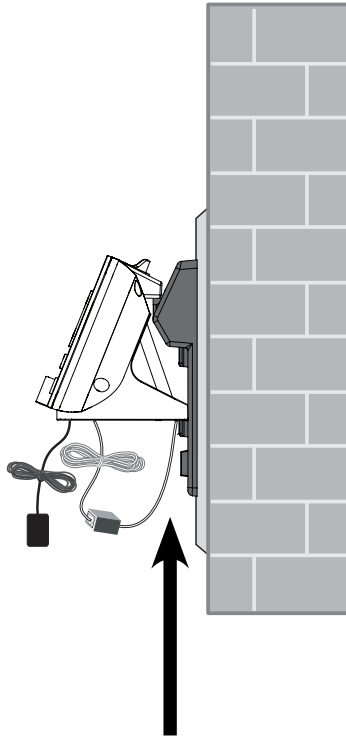

Getting started

Are you a new cable or VoIP subscriber?

If your answer is **yes**, the existing telephone jacks in your home may no longer work. Your cable/VoIP service provider uses a different connection, separate from your old traditional telephone service, to connect the modem/router/terminal adapter installed in your home.

To allow all existing telephone jacks to work, contact your telephone service provider for solutions, such as rewiring services (fees may apply).

If your answer is **no**, your existing telephone jacks will continue to work as normal.

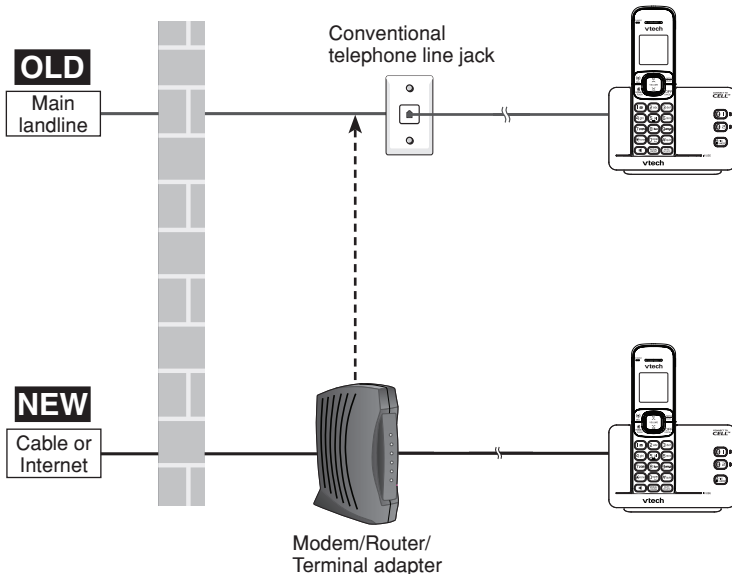

Did you subscribe to voicemail service from your telephone service provider?

This telephone does not have a built-in answering system. This telephone supports voicemail feature offered by your telephone service provider (subscription is required, and fees may apply).

To use the voicemail:

To retrieve your voicemail messages, you typically dial an access number provided by your telephone service provider, and then enter a security code. Contact your telephone service provider for instructions on how to configure the voicemail settings and listen to messages.

Getting started

Telephone base layout

📶 1 and 📶 2

- Press to connect the paired cell phone (page 16).
- Press and hold to add or replace a cell phone (page 15).

📶 1 and 📶 2 lights

- On when the telephone base is paired and connected with a Bluetooth device (page 15).
- Alternates when the telephone base is in discoverable mode.

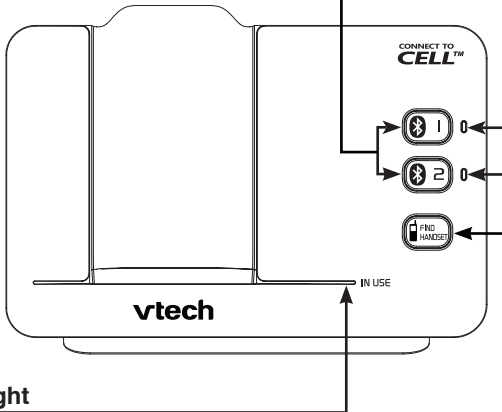

IN USE light

- Flashes when there is an incoming call, or another telephone sharing the same line is in use.
- On when the handset is in use.

📶 FIND HANDSET

- Press to page all system handsets (page 32).

Getting started

Handset layout

CHARGE light

- On when the handset is charging in the telephone base or handset charger (page 3).

VOLUME/ (directory)

- Press to review the directory when the phone is not in use (page 38).
- Press to increase the listening volume during a call (page 29).
- Press to scroll up while in a menu, or in the directory, caller ID log or redial list.
- While entering names or numbers, press to move the cursor to the right.

/CELL

- Press to make or answer a cell call (page 27).
- During a cell call, press to answer an incoming cell call when you hear a call waiting alert (page 28).

/HOME/FLASH

- Press to make or answer a home call (page 26).
- During a call, press to answer an incoming home call when you receive a call waiting alert (page 26).

1

- While reviewing a caller ID log entry, press repeatedly to add or remove 1 in front of the telephone number before dialing or saving it in the directory (page 46).
- Press and hold to set or dial your voicemail number (page 22).

tone

- During a call, press to switch to tone dialing if you have pulse service (page 31).

(Speakerphone)

- Press to make or answer a call using the handset speakerphone (pages 26 and 27).
- During a call, press to switch between the handset speakerphone and the cordless handset (page 29).

REDIAL/PAUSE

- Press repeatedly to view the last 10 numbers dialed (page 30).
- While entering numbers, press and hold to insert a dialing pause (pages 26, 27, 36 and 37).

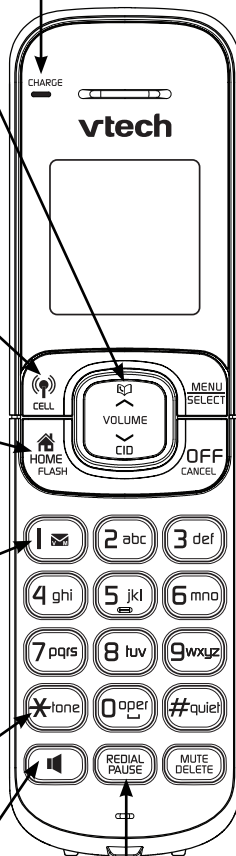

Getting started

Handset layout

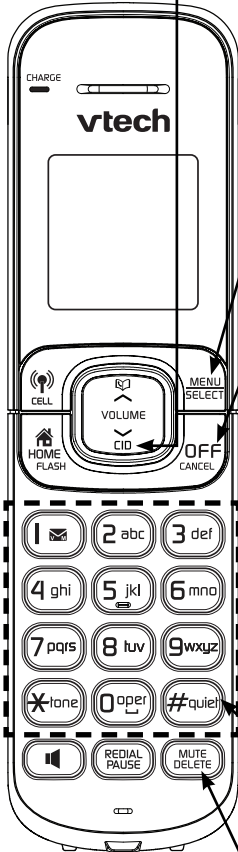

VOLUME/~/CID (caller ID)

- Press to review the caller ID log when the phone is not in use (page 45).
- Press to decrease the listening volume during a call (page 29).
- Press to scroll down while in a menu, or in the directory, caller ID log or redial list.
- While entering names or numbers, press to move the cursor to the left.

MENU/SELECT

- Press to show the menu (page 18).
- While in the menu, press to select an item or save an entry or setting.

OFF/CANCEL

- During a call, press to hang up (pages 26 and 28).
- While in a menu, press to return to the previous menu, or press and hold to return to idle mode, without making changes.
- Press to delete digits while predialing (pages 26 and 27).
- While the phone is ringing, press to silence the ringer temporarily (page 30).
- Press and hold to erase the missed call indicator when the phone is not in use (page 45).

Dialing keys

- Press to enter numbers or characters.
- Press to answer an incoming call.

#quiet

- Press repeatedly to display other dialing options while reviewing a caller ID log entry (page 46).
- Press and hold to set and turn on the quiet mode, or to turn it off (page 20).

MUTE/DELETE

- During a call, press to mute the microphone (page 29).
- While the phone is ringing, press to silence the ringer temporarily (page 30).
- While reviewing the redial list, directory or caller ID log, press to delete an individual entry (page 30, page 40 and page 48 respectively).
- While using the dialing keys, press to delete digits, or press and hold to return to idle mode.

Bluetooth

Introducing Bluetooth

Your new **DS6511** telephone system with Bluetooth wireless technology has the following features:

- Pair and connect up to a maximum of two cell phones with the telephone base to make and receive cell calls. Only one cell phone can be active on a call at a time.
- Make and receive calls using your cell phone plan while utilizing the ease and comfort of your home telephone system.
- Receive phonebook entries from your cell phone.

IMPORTANT INFORMATION

- Refer to the user's manual of your Bluetooth enabled cell phone for more information about how that device uses Bluetooth connectivity.
- Bluetooth wireless technology operates within a short range (a maximum of approximately 30 feet) from the telephone base. Keep connected cell phones within this range. For optimal performance, keep your cell phone within 15 feet of the telephone base while using the **DS6511** cell line.
- If your cell phone has poor reception in your home, the **DS6511** cannot improve the reception. However, if there is a location in your house with better reception, you can leave your cell phone at that location while using the **DS6511** cell line.
- If you experience poor sound quality, place your cell phone closer to the **DS6511** to ensure strong Bluetooth signal strength. Make sure there are no physical obstacles between the **DS6511** and the cell phone, such as large furniture or thick walls.

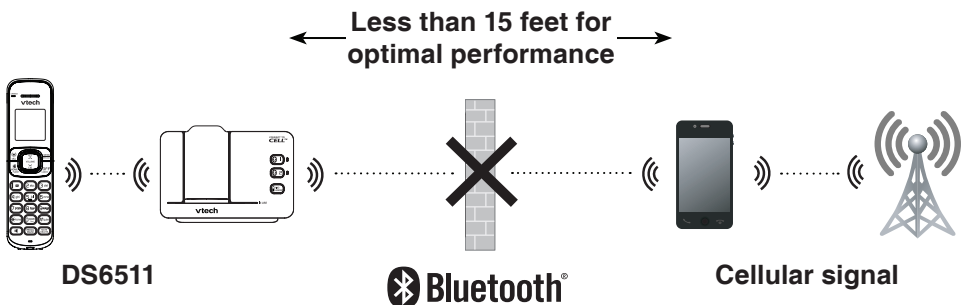

Bluetooth

IMPORTANT INFORMATION

- Charge your cell phone while it is connected to the telephone base. Your cell phone's battery will discharge faster while it is connected to the telephone base via Bluetooth wireless technology.
- Monitor your cell phone's usage because minutes are deducted from your cellular plan for the duration of all cell calls.

Refer to **Bluetooth setup** (page 15) to learn how to set up and manage your Bluetooth enabled devices. Refer to **Telephone operation** (page 26) on how to operate your Bluetooth devices with your new **DS6511** telephone system with Bluetooth wireless technology. Refer to **Troubleshooting** (page 55) if you experience difficulty using the telephone system.

The *Bluetooth*[®] word mark and logos are owned by Bluetooth SIG, Inc. and any use of such marks by VTech Holdings Limited is under license.

VTech Holdings Limited is a member of Bluetooth SIG, Inc. Other trademarks and trade names are those of their respective owners.



Bluetooth



Glossary of terms

Below are some terms used in this user's manual to help you become familiar with using your Bluetooth enabled cell phone and your new **DS6511** telephone system.

Bluetooth cell phone - refers to a Bluetooth enabled cellular telephone.

Cell line - the telephone line associated with your cell phone service. On your **DS6511** handset, press /CELL to use the cell line.

Connected - when you pair a Bluetooth cell phone to the **DS6511**, it is automatically connected. When a cell phone is connected, **1** and/or **2** displays after  on the handset and the  **1** and/or  **2** light on the telephone base is on. If a cell phone loses its connection to the telephone base, it must be reconnected before you can use the cell phone with the **DS6511**.

Disconnected - when a cell phone is disconnected, the  on the handset no longer displays and the  **1**/ **2** light on the telephone base is off.

Discoverable mode - before a Bluetooth enabled device can be paired, it must be set to this mode. When pairing your cell phone, the telephone base will be set to this mode. Depending on the manufacturer, this mode is sometimes referred to as **Find Me** or **Visibility**.

Home line - your conventional telephone land line. On your **DS6511** handset, press /HOME/FLASH to use the home line.

Paired device - once a Bluetooth enabled cell phone has been paired with the telephone base, it appears on the cell devices list. A maximum of two cell phones can be paired with the telephone base.

Pairing - this refers to the process of Bluetooth enabled cell phone registering device information with each other. The telephone base must be paired with the Bluetooth enabled cell phone before it can be used. Depending on the manufacturer, this is also referred to as **Bonding**.

PIN - by default, the PIN is **0000** for the telephone base and for most Bluetooth devices. PIN information must be exchanged between Bluetooth devices before they can be used. This is also known as a **Passkey** or **Passcode**.

Bluetooth

Bluetooth setup

To use a Bluetooth enabled cell phone with your **DS6511**, you must first pair and connect it with the telephone base. All **DS6511** handsets can be used to make or answer on the cell phone line.

Bluetooth wireless technology operates within a short range (30 feet). When you pair a Bluetooth cell phone to the telephone base, move closer to the telephone base to maintain sufficient signal strength. For optimal performance, keep your cell phone within 15 feet of the telephone base while using the cell line.





Add a cell phone

Before you begin, make sure that you have cellular coverage and your Bluetooth enabled cell phone is not connected to any other Bluetooth devices. Refer to your cell phone user's manual to learn how to search for or add new Bluetooth devices.

All paired cell phones are shown on the cell devices list.

Once you have paired and connected a device with the telephone base, you do not need to repeat the procedure again unless you want to replace the existing paired cell phone with a new one.





To pair and connect a cell phone:

1. Press and hold  1/ 2 on the telephone base for about four seconds. The  1/ 2 light blinks.

- If there is already a cell phone in the slot, the existing cell phone will be erased from cell devices list.

2. Turn on the Bluetooth feature of your cell phone. Once your cell phone finds your VTech phone (**VTech DS6511**), press the appropriate key on your cell phone to continue the pairing process.

- Your cell phone may prompt you to enter the PIN of the telephone base. The default PIN of the telephone base is **0000**.
- All cell phones that are connected to the telephone base are disconnected temporarily until the pairing process is completed.

3. When the cell phone is successfully paired and connected to the telephone base, the corresponding status icon ( 1/ 2) displays and the corresponding device light ( 1/ 2) turns on.

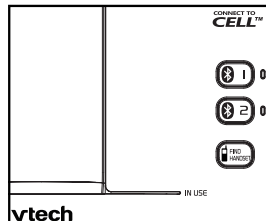

If you have trouble pairing your cell phone, it may not be compatible with your DS6511. Check the Bluetooth compatibility list at www.vtechphones.com.



note

- The pairing process may take up to one minute. If the pairing process fails, try again.
- The steps for the pairing process may vary for different cell phones. If this happens, follow the prompts on your cell phone and your **DS6511** to complete the pairing process.

Bluetooth

Auto connection

A cell phone may be disconnected from the telephone base when:

- The Bluetooth feature of your connected cell phone is turned off.
- The power of your cell phone is turned off.
- Your cell phone is not within range of the telephone base.

When the Bluetooth feature or power on the cell phone is turned on, or it moves within range of the base, the base will try to reconnect to the cell phone. If you disconnect the cell phone from the cell devices list, the base will not attempt to reconnect unless your cell phone is moved out of range and back in range again.

Connect a paired cell phone

If you need to connect your paired cell phone to the telephone base manually:

1. Press **1/2** on the telephone base when it is not in use. The **1/2** light blinks.
2. When the cell phone is connected to the telephone base, the corresponding status icon (**1/2**) displays and the corresponding device light (**1/2**) turns on.

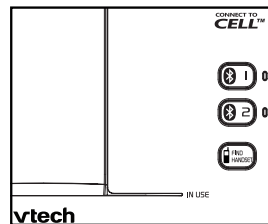

Disconnect a paired cell phone

If you need to disconnect a paired cell phone from the telephone base, refer to your cell phone user's manual for instructions to disconnect a Bluetooth device.

If you press and hold **1/2** on the telephone base, the existing paired cell phone in that slot will be erased. See **Add a cell phone** (page 15) on how to pair and connect a new cell phone.

Review the cell devices list

1. Press **MENU** on the handset when it is not in use.
2. Press **∨** or **∧** to highlight **Bluetooth**, then press **SELECT**.
3. Press **∨** or **∧** to highlight **Cell devices**, then press **SELECT**.

Bluetooth

Download directory

You can download up to 200 directories (phonebooks) to your **DS6511** telephone system via Bluetooth wireless technology. Each downloaded directory are stored in the handset directory with up to 24 digits for each phone number and 15 characters for each name.

Before downloading the directory, make sure the cell phone is paired and connected to the **DS6511**. Make sure the handset battery is charged for at least 10 minutes.

Place your cell phone next to the telephone base while downloading.

To download a cell phone directory:

1. Press **MENU** on the phone when it is not in use.
2. Press \vee or \wedge to highlight \blacklozenge **Bluetooth**, then press **SELECT**.
3. Press \vee or \wedge to highlight \blacklozenge **Download dir**, then press **SELECT**. The handset displays **Select a device** briefly.
 - If there is no cell phone paired to the system, the handset displays **Pair cell first** and then returns to the previous menu.
4. Press \vee or \wedge to highlight a desired device when necessary, then press **SELECT**.
 - If the selected device is not available, the handset displays **DX not avail** and then returns to the previous menu.

During the download, the handset flashes **Downloading...**
All other idle system handsets display **Downloading...**

5. When the downloading process completes or when the memory is full, the handset displays **Entries added: XXX**. Then the handset returns to the Bluetooth menu.

note

- Certain cell phones do not support SIM card download. If this is the case, try transferring the contacts from your SIM card to your cell phone memory first, then download from your cell phone memory. For more information on how to transfer contacts from your SIM card to your cell phone memory, see the user's manual of your cell phone.
- When downloading the directory from your Bluetooth enabled cell phone, some data may not transfer. For example, if you have home, mobile and work numbers for a particular contact, the three categories may not transfer to your **DS6511**.
- For certain cell phones, you may need to press a key on your cell phone to confirm the directory download.
- For Android and Blackberry cell phones, you may also download your cell phone directory to your **DS6511** via the VTech Contact Share application. Go to www.vtechphones.com/apps/contact_share for application download.

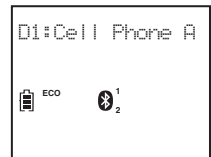

Telephone settings

Using the menu

You can use a cordless handset to change the telephone settings.

In the ringers menu, you can select the ringer tones and adjust the ringer volume for incoming calls.

In the settings menu, you can change the settings for LCD language, voicemail number, voicemail indicators, key tone, home area code and dial mode.

To enter the handset menu:

1. Press **MENU** when the phone is not in use.
 2. Press \downarrow or \uparrow until the screen displays the desired feature menu.
 3. Press **SELECT** to enter that menu.
- To return to the previous menu, press **CANCEL** on the handset.
 - To return to idle mode, press and hold **CANCEL** on the handset.

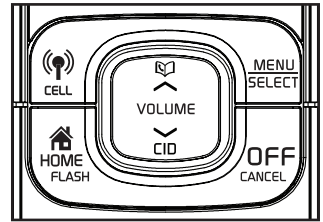

Telephone settings

Ringer volume

You can set the ringer volume or turn the ringer off on each handset. When the ringer is off,  appears on the screen.

1. Press **MENU** when the handset is not in use.
2. Press \vee or \wedge to highlight **◆Ringers**, then press **SELECT**.
3. Press \vee or \wedge to select **◆Home volume** or **◆Cell volume**, then press **SELECT**.
4. Press \vee or \wedge to sample each volume level.
5. Press **SELECT** to save your selection. Then the handset returns to the previous menu. You hear a confirmation tone.

note

The ringer volume also determines the ringer volume for intercom calls. If the ringer volume is set to off, that handset is silenced for all incoming calls except paging tone.

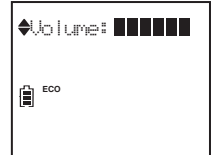
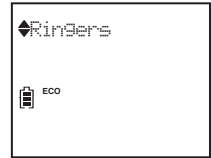

Ringer tone

You can choose from different ringer tones for each handset.

1. Press **MENU** when the handset is not in use.
2. Press \vee or \wedge to highlight **◆Ringers**, then press **SELECT**.
3. Press \vee or \wedge to highlight **◆Home ringtone** or **◆Cell ringtone**, then press **SELECT**.
4. Press \vee or \wedge to sample each ringer tone.
5. Press **SELECT** to save your selection. Then the handset returns to the previous menu. You hear a confirmation tone.

note

If you turn off the ringer volume, you will not hear ringer tone samples.

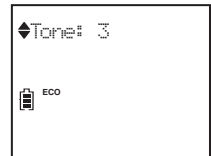

Telephone settings

Quiet mode

You can turn on the quiet mode for a period of time (1-12 hours). During this period, all tones (except paging tone) are muted.

To set the duration and turn on the quiet mode:

1. Press and hold **#**_{quiet} when the handset is not in use.
2. The handset displays **Quiet: __ hours**. Use the dialing keys (**0-9**) to enter the duration (1-12).
3. Press **SELECT** to confirm. You hear a confirmation tone. The handset displays **Quiet mode on** and .

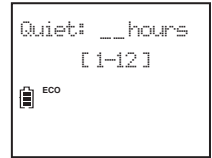

To turn off the quiet mode:

Press and hold **#**_{quiet} to turn off the quiet mode. The handset displays **Quiet mode off** briefly and then returns to idle.

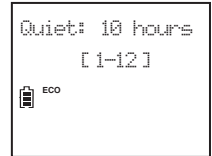

note

If you change the settings of the ringer tone and ringer volume while the quiet mode is on, you can still hear the samples of them.

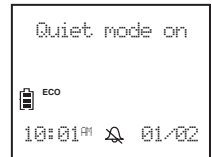

Telephone settings

Set date and time

If you subscribe to caller ID service, the day, month and time are set automatically with each incoming call. You can also set the date and time manually.

1. Press **MENU** when the handset is not in use.
2. Press \vee or \wedge to highlight **Set date/time**, then press **SELECT**.
3. Press \vee or \wedge to select the month then press **SELECT**, or use the dialing keys to enter a two-digit number (01-12).
4. Press \vee or \wedge to select the date then press **SELECT**, or use the dialing keys to enter a two-digit number (01-31).
5. Press \vee or \wedge to select the year then press **SELECT**, or use the dialing keys to enter a two-digit number (00-99) then press **SELECT**.
6. Press \vee or \wedge to select the hour then press **SELECT**, or use the dialing keys to enter a two-digit number (01-12).
7. Press \vee or \wedge to select the minute then press **SELECT**, or use the dialing keys to enter a two-digit number (00-59).
8. Press \vee or \wedge to highlight **AM** or **PM**.
9. Press **SELECT** to save the settings. Then the handset returns to the previous menu. You hear a confirmation tone.



note

The telephone plays two beeps if you enter an invalid number.

Telephone settings



LCD language

You can select a language (**English**, **French** or **Spanish**) to be used in all screen displays.

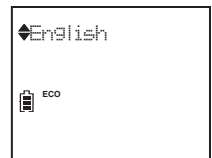
1. Press **MENU** when the handset is not in use.
2. Press \vee or \wedge to highlight \blacklozenge **Settings**, then press **SELECT**.
3. Press **SELECT** to select \blacklozenge **LCD language**.
4. Press \vee or \wedge to highlight **English**, **Français** or **Español**, then press **SELECT**.
 - The screen displays **Set English?** when you highlight **English**.
 - The screen displays **Set Francais?** when you highlight **Français**.
 - The screen displays **Set Espanol?** when you highlight **Español**.
5. Press **SELECT** to save your selection. Then the handset returns to the previous menu. You hear a confirmation tone.



Voicemail number

If you subscribe to voicemail service offered by your telephone service provider, you can save the voicemail number to **1**  for easy access. When you want to retrieve voicemail messages, press and hold 1 . Contact your telephone service provider for more information and assistance about using your voicemail service.

To set the voicemail number:

1. Press and hold 1  when the phone is not in use.
2. Use the dialing keys to enter the voicemail number.
 - Press **DELETE** to erase a digit.
 - Press and hold DELETE to erase all digits.
 - Press \vee or \wedge to move the cursor to the left or to the right.
 - Press and hold PAUSE to insert a dialing pause (a **p** appears).
3. Press **SELECT** to save. Then the handset dials the saved voicemail number.

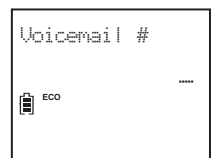
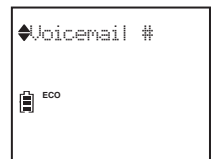

Telephone settings

Vicemail number

-OR-

1. Press **MENU** when the handset is not in use.
2. Press \vee or \wedge to highlight \blacklozenge **Settings**, then press **SELECT**.
3. Press \vee or \wedge to highlight \blacklozenge **VoiceMail #**, then press **SELECT**.
4. Use the dialing keys to enter the voicemail number.
 - Press **DELETE** to erase a digit.
 - Press and hold **DELETE** to erase all digits.
 - Press \vee or \wedge to move the cursor to the left or to the right.
 - Press and hold **PAUSE** to insert a dialing pause (a **p** appears).
5. Press **SELECT** to save. The handset displays **VM # saved** and then returns to the previous menu. You hear a confirmation tone.

Clear voicemail indicators

If you subscribe to voicemail service offered by your telephone service provider, **New voicemail** and  display on the handsets and the telephone base when you have new voicemail messages. Contact your telephone service provider for more information and assistance about using your voicemail service.

After you have listened to all new voicemail messages, the indicators on the handsets and the telephone base turn off automatically.

Use the clear voicemail feature when the telephone indicates that there is new voicemail but there are none (for example, when you have accessed your voicemail while away from home). Clearing the voicemail waiting indicators only turns off the indicators; it does not delete your voicemail messages. As long as you have new voicemail messages, your telephone service provider continues to send the signal to turn on the indicators.

To manually turn off the new voicemail indicators:

1. Press **MENU** when the handset is not in use.
2. Press \vee or \wedge to highlight \blacklozenge **Settings**, then press **SELECT**.
3. Press \vee or \wedge to highlight \blacklozenge **Clr voicemail**, then press **SELECT**.
The handset displays **Reset VM Icon?**
4. Press **SELECT** to confirm. Then the handset returns to the previous menu. You hear a confirmation tone.

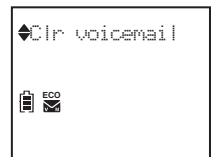

note

Your telephone service provider may alert you of new messages with a stutter (broken) dial tone. Contact your telephone service provider for details.

Telephone settings

Key tone

You can turn the key tone on or off for each handset. If you turn the key tone off, there are no beeps when you press the handset keys.

1. Press **MENU** when the handset is not in use.
2. Press \vee or \wedge to highlight **◆Settings**, then press **SELECT**.
3. Press \vee or \wedge to highlight **◆Key tone**, then press **SELECT**.
4. Press \vee or \wedge to highlight **◆Key tone:On** or **◆Key tone:Off**.
5. Press **SELECT** to save your selection. Then the handset returns to the previous menu. You hear a confirmation tone.

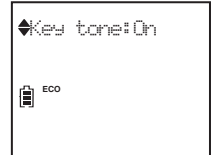
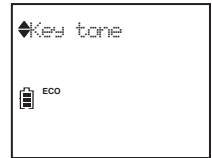

Home area code

If you dial your local calls using only seven digits (area code not required), you can program your home area code so that when you receive a call within your local area, the telephone number is automatically stored without the area code in the caller ID log.

1. Press **MENU** when the phone is not in use.
2. Press \vee or \wedge to highlight **◆Settings**, then press **SELECT**.
3. Press \vee or \wedge to highlight **◆Home area code**, then press **SELECT**.
4. Use the dialing keys to enter a three-digit home area code.
 - Press **DELETE** to delete a digit.
 - Press and hold **DELETE** to delete all digits.
5. Press **SELECT** to save your selection. Then the handset returns to the previous menu. You hear a confirmation tone.

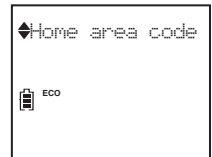

note

If, in the future, your telephone service provider requires you to dial the area code when making a local call, or, if you move to a location that requires it, delete the home area code you have already programmed, following the steps above. After you have deleted the home area code, `___` will appear on the display.

Telephone settings

Dial mode

The dial mode is preset to touch-tone dialing. If you have pulse (rotary) service, you must change the dial mode to pulse dialing before using the telephone to make a call.

1. Press **MENU** when the phone is not in use.
2. Press \vee or \wedge to highlight \blacklozenge **Settings**, then press **SELECT**.
3. Press \vee or \wedge to highlight \blacklozenge **Dial mode**, then press **SELECT**.
4. Press \vee or \wedge to choose \blacklozenge **Touch-tone** or \blacklozenge **Pulse**.
5. Press **SELECT** to save your selection. Then the handset returns to the previous menu. You hear a confirmation tone.

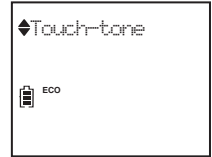
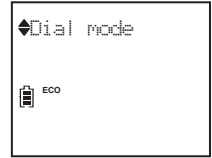

Website

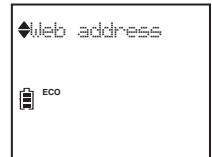

Use this feature to view the VTech website address.

1. Press **MENU** when the handset is not in use.
2. Press \vee or \wedge to highlight \blacklozenge **Web address**, then press **SELECT**.
The handset displays the website address.



Telephone operation



Make a home call

1. Press /HOME or  on the handset.
2. When you hear a dial tone, dial the number.
 - The handset displays **Unable to call** if the telephone line is in use.

note

- The handset shows the elapsed time as you talk (in hours, minutes and seconds).
- While entering numbers, press and hold PAUSE to insert a dialing pause (a **p** appears).

Predial a home call

1. Enter the telephone number.
2. Press /HOME or  to dial.
 - The handset displays **Unable to call** if the telephone line is in use.

note

- The handset shows the elapsed time as you talk (in hours, minutes and seconds).
- While entering numbers, press **DELETE** or **CANCEL** to make corrections; press and hold PAUSE to insert a dialing pause (a **p** appears).

Answer a home call

Press ,  or any dialing key (0-9, #^{quiet} or *^{tone}) to answer.

End a home call

Press **OFF** on the handset, or place the handset in the telephone base or handset charger.

Call waiting on the home line

When you subscribe to call waiting service with your telephone service provider, the handset flashes  and you hear a beep if someone calls while you are already on a call.

- Press **FLASH** on the handset to put your current call on hold and take the new call.
- Press **FLASH** on the handset at any time to switch back and forth between calls.

Telephone operation

Make a cell call

1. Press **☎/CELL** on the handset. The handset displays **Select a device**.
 - If you have only one cell phone connected to the telephone base, press **SELECT** and then the handset displays **D1 selected**.
 - If you have two cell phones connected to the telephone base, press **∨** or **∧** to select a cell phone and then press **SELECT**. Then the handset displays **D1/D2 selected**.
2. Enter the telephone number, then press **☎/CELL** to dial.
 - The handset displays **Unable to call** if your cell phone is in use.

note

- The handset shows the elapsed time as you talk (in hours, minutes and seconds).
- While entering numbers, press **DELETE** or **CANCEL** to make corrections; press and hold PAUSE to insert a dialing pause (a **p** appears).
- While using the cell line, place your cell phone closer to the telephone base, and make sure that there are no physical obstacles such as large furniture or thick walls between the telephone base and the cell phone.

Predial a cell call

1. Enter the telephone number.
2. Press **☎/CELL** to dial.
 - If you have only one cell phone connected to the telephone base, it is automatically selected to make cell calls.
 - If you have two cell phones connected to the telephone base, the handset displays **Select a device**. Press **∨** or **∧** to select a cell phone and then press **SELECT**.
 - The handset displays **Unable to call** if your cell phone is in use.

note

- The handset shows the elapsed time as you talk (in hours, minutes and seconds).
- While entering numbers, press **DELETE** or **CANCEL** to make corrections; press and hold PAUSE to insert a dialing pause (a **p** appears).

Answer a cell call

Press **☎/CELL**, **📞** or any dialing key (**0-9**, **#**_{quiet} or *****_{tone}) to answer.

note

You can also use your cell phone to answer the call. If you answer with your cell phone, it will disconnect from the telephone base.



Telephone operation

End a cell call

Press **OFF** on the handset, place the handset in the telephone base or handset charger.

Call waiting on the cell line

When you subscribe to call waiting service with your cell phone service provider, the handset flashes  and you hear a beep if someone calls while you are already on a call.

- Press /**CELL** on the handset to put your current call on hold and take the new call.
- Press /**CELL** on the handset at any time to switch back and forth between calls.

Answer a cell call while on a home call

While you are on a home call and you receive an incoming cell call, you hear a beep, and your handset flashes . The telephone base and all other handsets ring.

To answer the incoming cell call:

Press /**CELL** on the handset. The home line is put on hold.

To resume the home call on hold:

Press /**HOME** on the handset.

Cell phone voicemail

If you have voicemail service active on your cell phone, and you do not answer the incoming cell call, the call will be answered by your cell phone's voicemail. Contact your cell phone service provider for more information about voicemail service.

Answer a home call while on a cell call

While you are on a cell call and you receive an incoming home call, you hear a beep, and your handset flashes . The telephone base and all other handsets ring.

To answer the incoming home call:

Press /**HOME** on the handset. The cell line is put on hold.

To resume the cell call on hold:

Press /**CELL** on the handset.

Telephone operation

Speakerphone

When the handset is on a call, press **☎** to switch between the speakerphone and the handset earpiece. When the speakerphone is active, the handset displays **Speaker**.

Volume control

During a call, press **VOLUME/∩** or **VOLUME/∧**.

If this is a cell call and the volume is too loud or quiet, try changing the volume on your cell phone. On some cell phones, changing the volume on the cell phone affects your cell call volume on the **DS6511** handset.

note

- The handset and speakerphone volume settings are independent.
- When the volume reaches the minimum or maximum setting, you hear two beeps.

Mute

The mute function allows you to hear the other party but the other party cannot hear you.

- During a call, press **MUTE**. The handset displays **Muted** until the mute function is turned off.
- Press **MUTE** again to resume the conversation. The handset briefly displays **Microphone on**.



Telephone operation

Redial

Each handset stores the last 10 telephone numbers dialed (up to 30 digits).

To review and dial a redial number:

1. Press **REDIAL** to enter the redial list.
2. Press \vee , \wedge or **REDIAL** repeatedly to browse until the desired entry displays.
3. Press HOME or MUTE to dial using the home line.

-OR-

Press CELL to dial using the cell line.

-OR-

1. Press HOME or MUTE to use the home line.

-OR-

Press CELL to use the cell line.

2. Press **REDIAL** to enter the redial list.
3. Press \vee , \wedge or **REDIAL** repeatedly to browse until the desired entry displays.
4. Press **SELECT** to dial the displayed number.

To delete a redial number:

- When the handset displays the number you want to delete, press **DELETE**.



Temporary ringer silencing

When the telephone is ringing, you can temporarily silence the ringer of the handset without disconnecting the call. The next call rings normally at the preset volume.

To silence the ringer:

- Press **OFF** or **MUTE** on the handset and it displays **Ringer muted** and MUTE .

note

Each handset rings when there is an incoming call unless the ringer volume of that handset is turned off.

Telephone operation

Chain dialing

Use this feature to initiate a dialing sequence from numbers stored in the directory, caller ID log or redial list while you are on a call.

Chain dialing can be useful if you wish to access other numbers (such as bank account numbers or access codes) from the directory, caller ID log or redial list.

To access a number from the directory while on a call:

1. Press **MENU**.
2. Press **SELECT** to select **◆Directory**.
3. Press **∨** or **∧** to scroll to the desired entry.
4. Press **SELECT** to dial the displayed number.

To access a number from the caller ID log while on a call:

1. Press **MENU**.
2. Press **∨** or **∧** to highlight **◆Caller ID log**, then press **SELECT**.
3. Press **∨** or **∧** to scroll to the desired entry.
4. Press **SELECT** to dial the displayed number.

To access a number from the redial list while on a call:

1. Press **REDIAL** to enter the redial list.
2. Press **∨**, **∧** or **REDIAL** repeatedly to browse to the desired entry.
3. Press **SELECT** to dial the displayed number.

Temporary tone dialing

If you have pulse (rotary) service only, you can switch from pulse to touch-tone dialing temporarily during a call. This is useful if you need to send touch-tone signals to access your telephone banking or long distance services.

1. During a call, press **✕_{tone}**.
2. Use the dialing keys to enter the number you wish to dial.
3. The telephone sends touch-tone signals. The telephone automatically returns to pulse dialing mode after you end the call.

Telephone operation





Find handset

This feature helps you find misplaced handsets.

To start the paging tone:

- Press /FIND HANDSET on the telephone base. All idle handsets ring and their screens display **** Paging ****.

To stop the paging tone:

- Press /HOME, /CELL, OFF,  or any dialing key (0-9, #^{quiet} or *^{tone}) on a handset.
-OR-
- Press /FIND HANDSET on the telephone base.
-OR-
- Place the handset in the telephone base or charger.

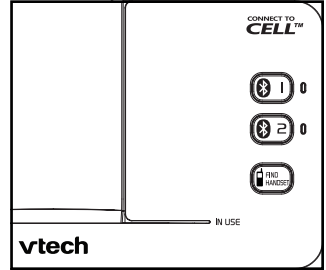

note Press **MUTE** to turn off the ringer of a handset temporarily. Paging tone continues on all other handsets.

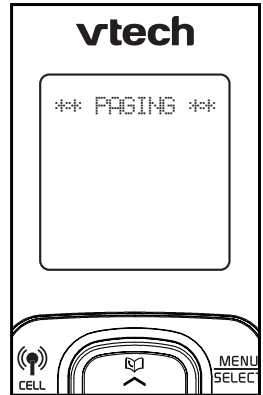



Multiple handset use

Join a call in progress

Another handset can join you on a home call. That call continues until all parties hang up. You can share an outside call with up to two handsets at the same time.







You can buy additional expansion handsets (**DS6501/DS6501-12/DS6501-15/DS6501-16**) for this telephone base. You can register up to five handsets to the telephone base.

To join a call:



- When a handset is already on a call, press /HOME or  on another handset to join the call.
- Press **OFF** or place the handset in the telephone base or handset charger to exit the call. The call continues on the other handset until both handsets hang up.

Transfer a call

While on an outside call, you can transfer the call from one handset to another.

1. During a call, press **MENU**.
2. Press  or  to highlight **Transfer**, then press **SELECT**.
3. Your handset shows **Transfer to:** Use the dialing keys to enter a handset number.
4. The outside call is put on hold and your handset shows **Calling HS X**. The other handset rings and shows **Incoming call**.
5. To answer the call on the destination handset, press /HOME, /CELL, or . Your handset displays **Transferred**. You hear a confirmation tone.

note

- If the destination handset is in the directory or caller ID log, or is out of range, your handset shows **Unable to call** and then automatically returns to the external call.
- If the destination handset does not answer the transferring call within 30 seconds, the call will be reverted to the originating handset. If you do not press /HOME, /CELL,  or any dialing key (**0-9**, **#**_{quiet} or *****_{tone}) on your handset to reconnect the outside call within 30 seconds, the call ends automatically.

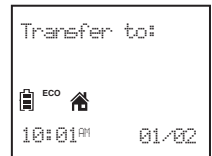

Multiple handset use

Intercom

Use the intercom feature for conversations between two system handsets.

To initiate an intercom call:

1. Press **MENU** when the handset is not in use.
2. Press \vee or \wedge to highlight \blacklozenge **Intercom**, then press **SELECT**.
3. Your handset shows **Intercom to:** Use the dialing keys to enter a handset number (1-5).

Your handset shows **Calling HS X**. The destination handset rings and shows **HS X is calling**.

4. To answer the intercom call on the destination handset, press HOME , CELL , MUTE or any dialing key (0-9, #quiet or *tone). Both handsets now show **Intercom**.
5. To end the intercom call on either handset, one party presses **OFF** or places the handset back in the telephone base or handset charger. Both handsets display **Intercom ended**.



note

- You can cancel the intercom call before it is answered by pressing **OFF**.
- If the destination handset does not answer the intercom call within 100 seconds, or if it is out of range, on a call, or accessing the directory or caller ID log, your handset displays **Unable to call** and then returns to idle mode.
- You can press **OFF** or **MUTE** on the destination handset to temporarily silence the intercom ringer.
- Only one intercom call can be established at a time.

Answer an incoming call during an intercom call

If you receive an incoming home call during an intercom call, you will hear an alert tone. Both handsets flash HOME and display the caller ID.

- To answer the call, press HOME . The intercom call ends automatically.
- To end the intercom call without answering or canceling the incoming call, press **OFF**. The intercom call ends and the telephone continues to ring.

If you receive an incoming cell call during an intercom call, you will hear an alert tone. Both handsets flash CELL and display the caller ID.

- To answer the call, press **OFF** to end the intercom call. The telephone continues to ring. Then press CELL .

Directory

About the directory

The directory stores up to 200 entries with up to 30 digits for each phone number and 15 characters for each name.

- Directory entries are shared by all handsets on both home line and cell line. Any modifications made on one handset apply to all.
- When you access the directory without records, the screen shows **Directory empty**.
- When the directory is full and you try to save an entry, the screen shows **Directory full**.
- When you try to save an entry already stored in the directory, the screen shows **Number repeated**.
- Only one system handset can review the directory at a time. When a handset tries to enter the directory while another is already in it, **Not available** displays.

Directory

Add a directory entry

1. Press **MENU** when the phone is not in use.
2. Press \vee or \wedge to highlight \blacklozenge **Directory**, then press **SELECT**.
3. Press **SELECT** to choose \blacklozenge **Add contact**.
4. When **Enter number** displays, use the dialing keys to enter a number (up to 30 digits).
 - Press \vee or \wedge to move the cursor to the left or right.
 - Press **DELETE** to erase a digit.
 - Press and hold **DELETE** to erase all digits.
 - Press and hold **PAUSE** to enter a dialing pause (a **p** appears).

-OR-

Copy a number from the redial list by pressing **REDIAL**. Then press \vee , \wedge or **REDIAL** repeatedly to find the desired number. Press **SELECT** to copy the number.

5. Press **SELECT** to move on to the name.
6. When **Enter name** displays, use the dialing keys to enter a name (up to 15 characters). Each time you press a key, the character on that key appears. Additional key presses produce other characters on that key. Press the key repeatedly until the desired character appears. The first character of every word is capitalized.
 - Press \vee or \wedge to move the cursor to the left or right.
 - Press **0** to add a space.
 - Press **DELETE** to erase a character.
 - Press and hold **DELETE** to erase all characters.
7. Press **SELECT** to save. The handset displays **Saved** and then returns to the previous menu. You hear a confirmation tone.

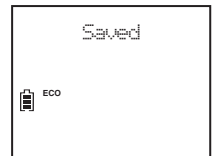
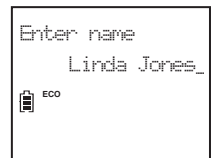
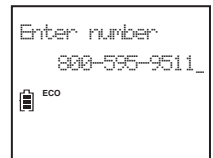

Directory

Add a directory entry

-OR-

1. Use the dialing keys to enter a number (up to 30 digits) when the phone is not in use. Press **SELECT**. The handset displays **Enter number**.
 - Press \vee or \wedge to move the cursor to the left or right.
 - Press **DELETE** to erase a digit.
 - Press and hold **DELETE** to erase all digits.
 - Press and hold **PAUSE** to enter a dialing pause (a **p** appears).

-OR-



Copy a number from the redial list by pressing **REDIAL**. Then press \vee , \wedge or **REDIAL** repeatedly to find the desired number. Press **SELECT** to copy the number.

2. Press **SELECT** to move on to the name.
3. When **Enter name** displays, use the dialing keys to enter a name (up to 15 characters). Each time you press a key, the character on that key appears. Additional key presses produce other characters on that key. Press the key repeatedly until the desired character appears. The first character of every word is capitalized.
 - Press \vee or \wedge to move the cursor to the left or right.
 - Press **0** to add a space.
 - Press **DELETE** to erase a character.
 - Press and hold **DELETE** to erase all characters.
4. Press **SELECT** to save. The handset displays **Saved** and then returns to the previous menu. You hear a confirmation tone.

Directory









Review directory entries

Directory entries appear alphabetically.

1. Press  when the phone is not in use. The handset displays **Entries in DIR XXX** for a few seconds, then displays the first entry in the directory.
2. Press  or  to browse through the directory.



-OR-

1. Press **MENU** when the phone is not in use.
2. Press  or  to highlight **Directory**, then press **SELECT**.
3. Press  or  to highlight **Review**, then press **SELECT**.
4. The handset displays **Entries in DIR XXX** for a few seconds and then displays the first directory entry. Press  or  to browse through the directory.









note

If the telephone number in the directory exceeds 15 digits, - appears in front of the telephone number and shows the remaining numbers alternately.

Alphabetical search

1. Press  when the phone is not in use.

-OR-

- i. Press **MENU** when the phone is not in use.
 - ii. Press  or  to highlight **Directory**, then press **SELECT**.
 - iii. Press  or  to highlight **Review**, then press **SELECT**.
2. Use the dialing keys to enter the letter associated with the name. For example, if you have the entries named Jennifer, Jessie, Kevin and Linda in your directory, press **5** (JKL) once to see Jennifer (when Jennifer displays, press  to see Jessie), twice to see Kevin, or three times to see Linda. If there is no name entry matching your search, the next closest match in alphabetical order appears. If necessary, press  or  to browse.

Directory

Dial a directory entry

1. Search for the desired entry in the directory (see **Review directory entries** or **Alphabetical search** on page 38).
2. Press /HOME or to dial using the home line; or press /CELL to dial using the cell line..

Edit a directory entry

1. Search for the desired entry in the directory (see **Review directory entries** or **Alphabetical search** on page 38).
2. When the desired entry displays, press **SELECT**. The handset displays **Edit number**.
3. Use the dialing keys to edit the number.
 - Press \vee or \wedge to move the cursor to the left or right.
 - Press **DELETE** to erase a digit.
 - Press and hold DELETE to erase all digits.
 - Press and hold PAUSE to enter a dialing pause (a **p** appears).
4. Press **SELECT**. The handset displays **Edit name**.
5. Use the dialing keys to edit the name.
 - Press \vee or \wedge to move the cursor to the left or right.
 - Press **DELETE** to erase a character.
 - Press and hold DELETE to erase all characters.
6. Press **SELECT** to save the entry. The handset displays **Saved** and then the revised entry. You hear a confirmation tone.

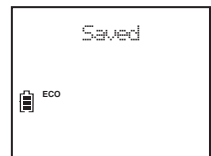
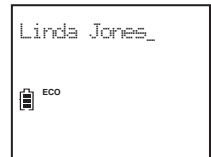

Directory

Delete a directory entry

1. Search for the desired entry in the directory (see **Review directory entries** or **Alphabetical search** on page 38).
2. Press **DELETE** and then the handset displays **Delete contact?**
3. Press **SELECT** to confirm. The handset displays **Deleting...** and then **Contact deleted**. The handset returns to the previous menu and you hear a confirmation tone.



Delete all contacts

1. Press **MENU** when the phone is not in use.
2. Press \vee or \wedge to highlight \blacklozenge **Directory**, then press **SELECT**.
3. Press \vee or \wedge to highlight \blacklozenge **Del all conts**, then press **SELECT**.
4. The handset displays **Delete all?** Press **SELECT** to confirm. The handset returns to the previous menu and you hear a confirmation tone.

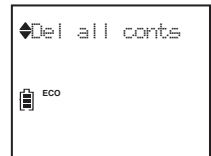

Directory

Speed Dial

You can copy nine of your directory entries to the speed dial locations (**0** and **2-9**) so that you can dial these numbers via the home line using fewer keys than usual. The speed dial entries are shared by all handsets.

Assign a speed dial entry

1. Press **MENU** when the phone is not in use.
2. Press \vee or \wedge to highlight **◆Directory**, then press **SELECT**.
3. Press \vee or \wedge to highlight **◆Speed dial**, then press **SELECT**.
4. Press \vee or \wedge to choose the desired speed dial location.
5. Press **SELECT** to show the directory.
6. Press \vee or \wedge to browse to the desired entry.

-OR-

Use the alphabetical search to find the desired entry (see page 38).

7. Press **SELECT** to save. You hear a confirmation tone.

note

If the directory is empty, when you press **SELECT** in Step 5, the screen shows **Directory empty**.

Reassign a speed dial entry

1. Press **MENU** when the phone is not in use.
2. Press \vee or \wedge to highlight **◆Directory**, then press **SELECT**.
3. Press \vee or \wedge to highlight **◆Speed dial**, then press **SELECT**.
4. Press \vee or \wedge to choose an occupied speed dial location.
5. Press **SELECT** twice and then press **SELECT** to choose **◆Reassign SD**.
6. Press **SELECT** to show the directory.
7. Press \vee or \wedge to browse to the desired entry.

-OR-

Use the alphabetical search to find the desired entry (see page 38).

8. Press **SELECT** to save. You hear a confirmation tone.

Directory

Dial a speed dial entry

- Press and hold a dialing key (**0** or **2-9**) to dial the number stored in the corresponding speed dial location via the home line.

note

When the speed dial location is empty, the handset shows the speed dial list. See **Assign a speed dial entry** on page 41 to add a new entry.

Delete a speed dial entry

1. Press **SELECT** when the phone is not in use.
2. Press \vee or \wedge to highlight **◆Directory**, then press **SELECT**.
3. Press \vee or \wedge to highlight **◆Speed dial**, then press **SELECT**.
4. Press \vee or \wedge to choose the desired speed dial location.
5. Press **DELETE**.
-OR-
Press **SELECT** twice. Press \vee or \wedge to highlight **◆Clear SD**, then press **SELECT**.
6. When the handset displays **Clear SD #X?**, press **SELECT**. You hear a confirmation tone.

note

Deleting the speed dial entries does not affect the entries in the directory.

Caller ID

About caller ID

This product supports caller ID services offered by most telephone service providers. Depending on your service subscription, you may see the caller's number, or the caller's name and number that are sent by your telephone service provider after the first or second ring. Caller ID allows you to see the name, number, date and time of calls.

Information about caller ID with call waiting

Caller ID with call waiting lets you see the name and telephone number of the caller before answering the call, even while on another call.

It may be necessary to change your telephone service to use this feature. Contact your telephone service provider if:

- You have both caller ID and call waiting, but as separate services (you may need to combine these services).
- You have only caller ID service, or only call waiting service.
- You do not subscribe to caller ID or call waiting services.

There are fees for caller ID services. In addition, services may not be available in all areas.

This product can provide information only if both you and the caller are in areas offering caller ID service and if both telephone service providers use compatible equipment. The time and date, along with the call information, are from the telephone service provider.

Caller ID information may not be available for every incoming call. Callers may intentionally block their names and/or telephone numbers. To view caller ID log entries with numbers between 16 and 24 digits, you must save the entry to the directory (see page 47).

You can use this product with regular caller ID service, or you can use this product's other features without subscribing to caller ID or combined caller ID with call waiting service.

Caller ID

Caller ID log

If you subscribe to caller ID service provided by your telephone service provider and/or cell phone service provider, information about each caller will appear after the first or second ring. If you answer a call before the caller's information appears, it will not be saved in the caller ID log.

- The caller ID log stores up to 50 entries. Each entry has up to 24 digits for the phone number and 15 characters for the name. If the phone number has more than 15 digits, only the last 15 digits appear. If the name has more than 15 characters, only the first 15 characters are shown and saved in the caller ID log.
- Caller ID log entries are shared by all system handsets. Any modifications made on one handset apply to all.
- You can review, redial, and copy an entry into the directory.
- Entries appear in reverse chronological order.
- When the caller ID log is full, the oldest entry is deleted to make room for new incoming call information.
- **XX missed calls** shows when there are new caller ID log entries that have not been reviewed.
- **Call log empty** shows when you access the caller ID log without records.
- Only one system handset can review the caller ID log at a time. If a handset tries to enter the caller ID log while another handset is already in it, its screen displays **Not available**.

Memory match

If the incoming telephone number matches the last seven digits of a telephone number in your directory, the name that appears on the screen matches the corresponding name in your directory.

For example, if Mike Smith calls, his name appears as **Mike** if this is how you entered it into your directory.

note

The number shown in the caller ID log will be in the format sent by the telephone service provider. The telephone service provider usually delivers 10-digit phone numbers (area code plus telephone number). If the phone number of the caller does not match a number in your directory, the name will appear as it is delivered by the telephone service provider.

Caller ID

Missed call indicator

When there are calls that have not been reviewed in the caller ID log, the handsets display **XX missed calls**. When you have reviewed all the missed calls, the missed call indicator goes away.

Each time you review a caller ID log entry marked **NEW**, the number of missed calls decreases by one.

If you do not want to review the missed calls one by one, press and hold **CANCEL** on the handset when not in use to clear the missed call indicator. All the entries are then considered old and kept in the caller ID log.

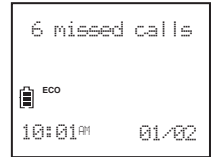

Review the caller ID log

Review the caller ID log to find out who called, to return the call, or to copy the caller's name and number into your directory.

1. Press **CID** when the phone is not in use. The handset displays **Entries in CID XX** for a few seconds.

2. Press \vee or \wedge to browse.

-OR-

1. Press **MENU** when the phone is not in use.

2. Press \vee or \wedge to scroll to **Caller ID log**, then press **SELECT**.

3. Press **SELECT** to choose **Review**.

4. The handset displays **Entries in CID XX** for a few seconds.

5. Press \vee or \wedge to browse. You hear a double beep when you reach the beginning or end of the caller ID log.

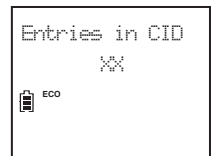
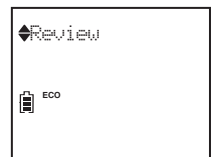
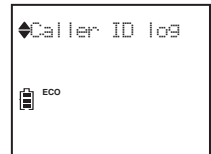

Caller ID

View dialing options

Although the caller ID log entries received have 10 digits (the area code plus the seven-digit number), in some areas, you may need to dial only the seven digits, or 1 plus the seven digits, or 1 plus the area code plus the seven digits. You can change the number of digits that you dial from the caller ID log and store the new number to the directory.

While reviewing the caller ID log, press **#**_{quiet} (pound key) repeatedly to display different dialing options for local and long distance numbers before dialing or saving the telephone number in the directory.

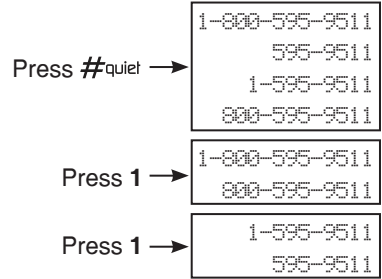

Press **1** repeatedly if you need to add or remove 1 in front of the telephone number before dialing or saving it in the directory.

When the number is displayed in the correct format for dialing, press **HOME**, **CELL** or **CALL** to dial.



Caller ID

Dial a caller ID log entry

1. Search for the desired caller ID log entry (see **Review the caller ID log** on page 45).
2. When the desired entry displays, press /HOME, /CELL or  to dial.

Save a caller ID log entry to the directory

1. Search for the desired caller ID log entry (see **Review the caller ID log** on page 45).
2. When the desired entry displays, press **SELECT**. Then the handset displays **Edit number**.
3. Use the dialing keys to edit the number, when necessary.
 - Press \vee or \wedge to move the cursor to the left or right.
 - Press **DELETE** to backspace and erase a digit.
 - Press and hold **DELETE** to erase the entire entry.
 - Press and hold **PAUSE** to insert a dialing pause (a **p** appears).
4. Press **SELECT** to move to the name. The handset displays **Edit name**.
5. Use the dialing keys to add or edit the name.
 - Press \vee or \wedge to move the cursor to the left or right.
 - Press **DELETE** to erase a character.
 - Press and hold **DELETE** to erase all characters.
6. Press **SELECT** when done and the screen shows **Saved**.

note

If you save an entry which already exists in the directory, the handset displays **Number repeated** and then returns to previous screen.

Caller ID

Delete caller ID log entries

To delete one entry:

1. Search for the desired caller ID log entry (see **Review the caller ID log** on page 45).
2. Press **DELETE** to delete the displayed entry.

To delete all entries:

1. Press **MENU** when the phone is not in use.
2. Press \vee or \wedge to scroll to \blacktriangleleft **Caller ID log**, then press **SELECT**.
3. Press \vee or \wedge to scroll to \blacktriangleleft **Del all calls**, then press **SELECT**.
4. When the screen shows **Delete all?**, press **SELECT** to delete all caller ID log entries. You hear a confirmation tone.

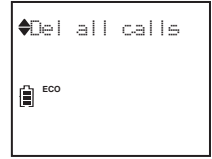

Caller ID log screen messages

Displays:	When:
PRIVATE NAME	The caller is blocking the name.
PRIVATE NUMBER	The caller is blocking the telephone number.
PRIVATE CALLER	The caller is blocking the name and number.
UNKNOWN NAME	This caller's name is unavailable.
UNKNOWN NUMBER	This caller's number is unavailable.
UNKNOWN CALLER	No information is available about this caller.

Appendix

Screen messages

Call log empty	There are no entries in caller ID log history.
Transferred	You have transferred an outside call to another handset.
Calling HS X	The handset is calling another handset (for intercom calls).
Cell line busy	Another system handset is using the cell line.
Contact deleted	A directory entry is deleted.
Directory empty	There are no directory entries.
Directory full	The directory is full. You cannot save any new entries unless you delete some current entries.
Downloading...	The telephone system is downloading the directory from a cell phone.
Ended	You have just ended a call.
HS X is calling	Another system handset is calling (for intercom calls).
Home line busy	Another system handset is using the home line.
Incoming call	There is a call coming in.
Intercom	The handset is on an intercom call.
Intercom ended	The intercom call has just ended.
Intercom to: (for models with two or more handsets)	You have started the intercom process, and need to enter the desired handset number.
Line in use	An extension phone, or one of the handsets is in use.
Low battery	The handset battery needs to be recharged.
Microphone on	The mute function is turned off and the other party can hear you.
Muted	The microphone is off. The other party cannot hear you.
New voicemail	There are new voicemail messages from your telephone service provider.
NO BATTERY	The handset in the telephone base or handset charger has no battery installed.
No line	There is no telephone line connection.
Not available	Someone else is using the directory or caller ID log history. The cell line is not ready to use.
Number repeated	The entry you try to save is already in the directory.
Out of range or no PWR at base	The telephone base has lost power, or the handset is out of range.

Appendix

Screen messages

** Paging **	The handset is paged by the telephone base.
Pair cell first	You need to pair a cell phone before making a cell call.
Phone	The handset is on a home call.
Put in charger	The battery is very low. The handset should be charged.
Quiet mode on	The telephone system is in quiet mode.
Registering...	The handset is registering to the telephone base.
Failed	The handset registration is not successful.
Ringer off	The ringer is off temporarily during an incoming call.
Saved	The entry is saved in the directory.
Speaker	The handset speakerphone is in use.
To register HS... ...see manual	Screen display on a non-registered handset.
Transfer to:	You have started transferring an outside call, and need to enter the desired handset number.
Unable to call	The handset is out of range while on a call. Failed phone call (the telephone line is in use). Failed intercom call (there are already two handsets being used).
XX missed calls	There are new calls in the caller ID log.



Appendix

Handset and telephone base indicators

Handset lights

	On when the handset speakerphone is in use.
CHARGE	On when the handset is charging in the telephone base or handset charger.









Telephone base lights

IN USE	On when the telephone line is in use. On when you are registering a handset. Flashes quickly when there is an incoming call. Flashes when another telephone sharing the same line is in use. Flashes when you are deregistering all handsets.
 1/  2	On when a Bluetooth device is connected to the base. Alternates when the telephone base is in discoverable mode.

Appendix

Handset and telephone base indicators

Handset icons

	The battery icon flashes when the battery is low and needs charging.
	The battery icon animates when the battery is charging.
	The battery icon becomes solid when the battery is fully charged.
ECO	The ECO mode activates automatically to reduce power consumption when the handset is within range from the telephone base.
	There are new voicemail received from your telephone service provider.
	On when the home line is in use or there is an incoming home call. Flashes when there is an incoming home waiting call.
	There are Bluetooth devices connected on the cell devices list.
	On when the cell line is in use or there is an incoming cell call. Flashes when there is an incoming cell waiting call.
NEW	There are new caller ID log entries.
	The ringer is off.

Appendix

Expand your telephone system

You can add new handsets (**DS6501/DS6501-12/DS6501-15/DS6501-16**, purchased separately) to your telephone system. Your telephone base supports a maximum of five handsets.

For more details, refer to the user's manual that comes with your **DS6501/DS6501-12/DS6501-15/DS6501-16** new handset.

Appendix

Troubleshooting

If you have difficulty with your telephone, please try the following suggestions. For customer service, visit our website at www.vtechphones.com or call 1 (800) 595-9511. In Canada, go to www.vtechcanada.com or dial 1 (800) 267-7377.

I cannot add my cell phone to the telephone base.

- Make sure you have cellular coverage.
- Make sure your cell phone is compatible with your **DS6511**. Check the Bluetooth compatibility list at www.vtechphones.com.
- Make sure the Bluetooth function of your cell phone is turned on. See the user's manual of your cell phone for more information.
- Remove **VTech DS6511** from your cell phone's handsfree device history list (see the user's manual of your cell phone for more information).
- Carefully follow the pairing instructions on page 15 and make sure that your cell phone is not connected to any other Bluetooth device.
- Turn off your cell phone, then turn it on again.
- Reset the telephone base. Unplug the unit's electrical power. Wait for approximately 15 seconds, then plug it back in. Repeat the above suggestions.

I cannot connect my cell phone with the telephone base.

- Make sure that the Bluetooth function of your cell phone is turned on. See the user's manual of your cell phone for more information.
- Make sure that your Bluetooth cell phone is not connected to any other Bluetooth device.
- Turn off your cell phone, then turn it on again.
- Make sure that your cell phone is connected and active on the cell devices list.
- For some cell phones, you must authorize **VTech DS6511** device in your cell phone's Bluetooth feature. See the user's manual of your cell phone for more information.
- Manually connect your cell phone to **VTech DS6511**. Refer to the user's manual of your cell phone for more information.

I cannot find VTech DS6511 on my cell phone.

- Make sure that the telephone base is in discoverable mode. Carefully follow the setup instructions on page 15.
- Make sure that you manually set your cell phone to search for devices.
- Remove **VTech DS6511** from your cell phone's handsfree device history list (see the user's manual of your cell phone).
- Turn off your cell phone, then turn it on again.
- Reset the telephone base. Unplug the unit's electrical power. Wait for approximately 15 seconds, then plug it back in. Repeat the above suggestions.

Appendix

Troubleshooting

I don't know how to search for or add new devices on my cell phone.

- Most cell phones have the Bluetooth feature in the connection or setup menus. Refer to the user's manual of your cell phone.
- In general, press the menu key on your cell phone, then look for the Bluetooth menu in the settings or connection menu. In the Bluetooth menu, select the option to search for or add new devices.

My cell phone disconnects from the telephone base.

- Turn off your cell phone, then turn it on again.
- Make sure that you are not using your cell phone when on a cell call.

My cell phone is connected to the telephone base, but I cannot make a cell call.

- Make sure that your cell phone is not in use when you are trying to make a cell call.
- For some smartphones, make sure that the cellular function is turned on.

The PIN on the telephone base does not work.

- Make sure you enter the correct PIN. The default PIN is **0000**.

I cannot hear any audio on my telephone system when on a cell call.

- Reset the telephone base. Unplug the unit's electrical power. Wait for approximately 15 seconds, then plug it back in.
- Turn off your cell phone, then turn it on again.

I cannot download contacts from my cell phone to the DS6511.

- Make sure that your cell phone is paired and connected to the base.
- Make sure you place your cell phone next to the base while downloading.

Can the DS6511 help the poor cell phone reception in my house?

- If your cell phone has poor reception in your home, the **DS6511** cannot improve the reception. However, if there is a location in your house with better reception, you can leave your cell phone at that location while using the **DS6511** cell line. In order for this to work, the telephone base must be within 30 feet of the cell phone.

The listening volume of my cell call is too loud or quiet.

- During a cell call, if the listening volume is too loud or quiet, try changing the volume on your cell phone. On some cell phones, changing the volume on the cell phone affects your cell call volume on the **DS6511** handset.

Appendix

Troubleshooting

My telephone doesn't work at all.

- Make sure the power cord is securely plugged in.
- Make sure you plug the battery connector securely into the cordless handset.
- Make sure you plug the telephone line cord securely and firmly into the telephone base and the telephone wall jack.
- Unplug the electrical power to the telephone base. Wait for approximately 15 seconds, then plug it back in. Allow up to one minute for the cordless handset and telephone base to synchronize.
- Charge the battery in the cordless handset for at least 12 hours. For optimum daily performance, return the cordless handset to the handset charger when not in use.
- If the battery is completely depleted, charge the handset for at least 30 minutes before use (page 4).
- Reset the telephone base. Unplug the electrical power. Wait for approximately 15 seconds, then plug it back in. Allow up to one minute for the cordless handset and telephone base to reset.
- You may need to purchase a new battery. Refer to **Handset battery installation** (page 3) and **Handset battery charging** (page 4).
- Disconnect the telephone base from the telephone wall jack and plug in a working telephone. If the other telephone does not work, the problem is probably in the wiring or telephone service. Contact your telephone service provider.

The display shows No line. I cannot get a dial tone.

- Try all the suggestions, above.
- If the previous suggestions do not work, disconnect the telephone base from the telephone jack and connect to a different phone. If there is no dial tone on that phone either, the problem is in your wiring or telephone service. Contact your telephone service provider.
- Your line cord may be defective. Try installing a new line cord.
- If you have changed your telephone service to digital service from a cable company or a VoIP service provider, the telephone line may need to be rewired to allow all existing telephone jacks to work. Contact your service provider for more information.

Appendix

Troubleshooting

I cannot dial out.

- Try all the suggestions above.
- Make sure you have a dial tone before dialing. The cordless handset may take a second or two to find the telephone base and produce a dial tone. This is normal. Wait an extra second before dialing.
- Eliminate any background noise. Noise from a television, radio or other appliances might cause the phone to not dial out properly. If you cannot eliminate the background noise, first try muting the cordless handset before dialing, or dialing from another room with less background noise.
- If other phones in your home are having the same problem, contact your telephone service provider (charges may apply).
- If you have changed your telephone service to digital service from a cable company or a VoIP service provider, the telephone line may need to be rewired to allow all existing telephone jacks to work. Contact your service provider for more information.

The display shows **To register HS...** and **...see manual alternately**. The handset does not work at all.

- The handset is deregistered from the telephone base.
 1. Place the handset in the telephone base to register it back. The handset shows **Registering...** then **Registered** and you hear a beep when the registration process completes. This process takes about 90 seconds to complete.
 2. If registration fails, the handset displays **Failed**. Try the registration process again.

My cordless handset isn't performing normally.

- Make sure you plug the power cord securely into the telephone base. Plug the power adapter into a different, working electrical outlet without a wall switch.
- Move the cordless handset closer to the telephone base. You may have moved out of range.
- Reset the telephone base. Unplug the electrical power. Wait for 15 seconds then plug it back in. Allow up to one minute for the cordless handset and telephone base to reset.
- Other electronic products such as HAM radios and other DECT phones can cause interference with your cordless phone. Try installing your phone as far away as possible from these types of electronic devices.

Appendix

Troubleshooting

Out of range or no pwr at base appears on my cordless handset.

- Ensure you plug the telephone base in properly and the power is on.
- Place the cordless handset closer to the telephone base for synchronization.
- Move the cordless handset closer to the telephone base. You may have moved out of range.
- Reset the telephone base. Unplug the electrical power. Wait for 15 seconds then plug it back in. Allow up to one minute for the cordless handset and telephone base to reset.
- Other electronic products such as HAM radios and other DECT phones can cause interference with your cordless phone. Try installing your phone as far away as possible from these types of electronic devices.

The battery does not charge in the handset, or the handset battery does not accept charge.

- If the cordless handset is in the telephone base or handset charger and the charge light is not on, refer to **The charge light is off** (page 61).
- Charge the battery in the cordless handset for at least 12 hours. For optimum daily performance, return the cordless handset to the handset charger when not in use.
- If the battery is completely depleted, charge the handset for at least 30 minutes before use (page 4).
- You may need to purchase a new battery. Please refer to **Handset battery installation** (page 3) and **Handset battery charging** (page 4).

I get noise, static, or weak signals even when I'm near the telephone base.

- If you subscribe to high-speed Internet service (DSL - digital subscriber line) through your telephone line, you must install a DSL filter between the telephone line cord and the telephone wall jack (page 2). The filter prevents noise and caller ID problems as a result of DSL interference. Please contact your DSL service provider for more information about DSL filters.
- You may be able to improve the performance of your cordless phone by installing your new telephone base as far as possible from any other existing cordless telephone system that may already be installed.
- Other electronic products such as HAM radios and other DECT phones can cause interference with your cordless phone. Try installing your phone as far away as possible from these types of electronic devices.
- Do not install this phone near a microwave oven or on the same electrical outlet. You may experience decreased performance while the microwave oven is operating.

Appendix

Troubleshooting

- If you plug your phone in with a modem or a surge protector, plug the phone (or modem/surge protector) into a different location. If this does not solve the problem, relocate your phone or modem farther apart from one another, or use a different surge protector.
- Relocate your phone to a higher location. The phone may have better reception in a high area.
- If other phones in your home are having the same problem, contact your telephone service provider (charges may apply).

I experience poor sound quality when using the speakerphone.

- For increased sound quality while using the speakerphone, place the handset on a flat surface with the dialing keys facing up.

I hear other calls while using my phone.

- Disconnect the telephone base from the telephone jack, and plug in a different telephone. If you still hear other calls, contact your telephone service provider.

The telephone does not ring when there is an incoming call.

- Make sure that the ringer is not off. Refer to **Ringer volume** on page 19 in this user's manual.
- Make sure you plug in the telephone line cord securely into the telephone base and the telephone jack. Make sure you plug in the power cord securely.
- The cordless handset may be too far from the telephone base.
- Charge the battery in the cordless handset for at least 12 hours. For optimum daily performance, return the cordless handset to the handset charger when not in use.
- You may have too many extension phones on your telephone line to allow all of them to ring simultaneously. Try unplugging some of the other phones.
- The layout of your home or office might be limiting the operating range. Try moving the telephone base to another location, preferably to a higher location.
- If other phones in your home are having the same problem, contact your telephone service provider (charges may apply).
- Test a working phone at the phone jack. If another phone has the same problem, contact your telephone service provider (charges may apply).
- Other electronic products such as HAM radios and other DECT phones can cause interference with your cordless phone. Try installing your phone as far away as possible from these types of electronic devices.

Appendix

Troubleshooting

- Remove and install the battery again. Place the cordless handset in the telephone base or handset charger. Wait for the cordless handset to reestablish its connection with the telephone base. Allow up to one minute for this to take place.
- Your line cord may be defective. Try installing a new line cord.

My calls cut in and out while I'm using my cordless handset.

- Other electronic products such as HAM radios and other DECT phones can cause interference with your cordless phone. Try installing your phone as far away as possible from these types of electronic devices.
- Do not install this phone near a microwave oven or on the same electrical outlet. You may experience decreased performance while the microwave oven is operating.
- If you plug your phone in with a modem or surge protector, plug the phone (or modem/surge protector) into a different location. If this does not solve the problem, relocate your phone or modem farther apart from one another, or use a different surge protector.
- Relocate your telephone base to a higher location. The phone may have better reception when installed in a high area.
- If other phones in your home are having the same problem, contact your telephone service provider (charges may apply).

The charge light is off.

- Make sure you plug the power and line cords in correctly and securely.
- Unplug the electrical power. Wait for 15 seconds, then plug it back in. Allow up to one minute for the cordless handset and telephone base to reset.
- Clean the charging contacts on the cordless handset, telephone base and handset charger each month with a pencil eraser or a dry non-abrasive cloth.

My caller ID isn't working properly.

- Caller ID is a subscription service. You must subscribe to this service from your telephone service provider for this feature to work on your phone.
- The caller must be calling from an area that supports caller ID.
- Both your and your caller's telephone service providers must use caller ID compatible equipment.
- If you subscribe to high-speed Internet service (DSL - digital subscriber line) through your telephone line, you must install a DSL filter between the telephone line cord and the telephone wall jack (page 2). The filter prevents noise and caller ID problems resulting from DSL interference. Please contact your DSL service provider for more information about DSL filters.

Appendix

Troubleshooting

My telephone does not receive caller ID when on a call.

- Make sure you subscribe to caller ID with call waiting features from your telephone service provider. Caller ID feature works only if both you and the caller are in areas offering caller ID service, and if both telephone service providers use compatible equipment.

New voicemail and show and I don't know why.

- If **New voicemail** and  appear, then your telephone has received a signal from your telephone service provider that you have a voicemail message waiting for you to retrieve from them. Contact your telephone service provider for more information on how to access your voicemail.

I cannot retrieve voicemail messages.

- If you subscribe to voicemail service from your telephone service provider, contact your telephone service provider for more information on how to access your voicemail.

I subscribe to a nontraditional telephone service that uses my computer to establish connections, and my telephone doesn't work.

- Make sure your computer is powered on.
- Make sure your Internet connection is working properly.
- Make sure that the software is installed and running for your nontraditional telephone service.
- Make sure to plug your USB telephone adapter into a dedicated USB port on your computer. Do not plug into a multiple port USB hub (USB splitter) that is not powered.
- In a few rare instances, the USB port on your computer may not have enough power. In these instances, try using a USB hub with its own external power supply.
- If you are using a firewall, it may prevent access to your nontraditional telephone service provider. Contact your service provider for more information.

I accidentally changed the LCD language to French or Spanish, and I don't know how to change it back to English.

- While the phone is not in use, press **MENU**, then enter *^{tone}364 #^{quiet} to reset the LCD language to English.
- While the phone is on a call, press **MENU**, then enter *^{tone}364 #^{quiet} to reset the LCD language to English. Then the call ends.

Appendix

Troubleshooting

Common cure for electronic equipment.

- If the telephone is not responding normally, do the following (in the order listed):
 1. Disconnect the power to the telephone base.
 2. Disconnect the cordless handset battery.
 3. Wait a few minutes.
 4. Connect power to the telephone base.
 5. Install the battery again, and place the cordless handset in the telephone base.
 6. Wait for the cordless handset to reestablish its connection with the telephone base. Allow up to one minute for this to take place.

Appendix

Important safety instructions

When using your telephone equipment, basic safety precautions should always be followed to reduce the risk of fire, electric shock and injury, including the following:

1. Read and understand all instructions.
2. Follow all warnings and instructions marked on the product.
3. Unplug this product from the wall outlet before cleaning. Do not use liquid or aerosol cleaners. Use a damp cloth for cleaning.
4. Do not use this product near water such as near a bath tub, wash bowl, kitchen sink, laundry tub or swimming pool, or in a wet basement or shower.
5. Do not place this product on an unstable table, shelf, stand or other unstable surfaces.
6. Avoid placing the telephone system in places with extreme temperature, direct sunlight, or other electrical devices. Protect your phone from moisture, dust, corrosive liquids and fumes.
7. Slots and openings in the back or bottom of the telephone base and handset are provided for ventilation. To protect them from overheating, these openings must not be blocked by placing the product on a soft surface such as a bed, sofa or rug. This product should never be placed near or over a radiator or heat register. This product should not be placed in any area where proper ventilation is not provided.
8. This product should be operated only from the type of power source indicated on the marking label. If you are not sure of the type of power supply in your home or office, consult your dealer or local power company.
9. Do not allow anything to rest on the power cord. Do not install this product where the cord may be walked on.
10. Never push objects of any kind into this product through the slots in the telephone base or handset because they may touch dangerous voltage points or create a short circuit. Never spill liquid of any kind on the product.
11. To reduce the risk of electric shock, do not disassemble this product, but take it to an authorized service facility. Opening or removing parts of the telephone base or handset other than specified access doors may expose you to dangerous voltages or other risks. Incorrect reassembling can cause electric shock when the product is subsequently used.
12. Do not overload wall outlets and extension cords.
13. Unplug this product from the wall outlet and refer servicing to an authorized service facility under the following conditions:
 - When the power supply cord or plug is damaged or frayed.
 - If liquid has been spilled onto the product.
 - If the product has been exposed to rain or water.
 - If the product does not operate normally by following the operating instructions. Adjust only those controls that are covered by the operation instructions. Improper adjustment of other controls may result in damage and often requires extensive work by an authorized technician to restore the product to normal operation.
 - If the product has been dropped and the telephone base and/or handset has been damaged.
 - If the product exhibits a distinct change in performance.
14. Avoid using a telephone (other than cordless) during an electrical storm. There is a remote risk of electric shock from lightning.
15. Do not use the telephone to report a gas leak in the vicinity of the leak. Under certain circumstances, a spark may be created when the adapter is plugged into the power outlet, or when the handset is replaced in its cradle. This is a common event associated with the closing of any electrical circuit. The user should not plug the phone into a power outlet, and should not put a charged handset into the cradle, if the phone is located in an environment containing concentrations of flammable or flame-supporting gases, unless there is adequate ventilation. A spark in such an environment could create a fire or explosion. Such environments might include: medical use of oxygen without adequate ventilation; industrial gases (cleaning solvents; gasoline vapors; etc.); a leak of natural gas; etc.
16. Only put the handset of your telephone next to your ear when it is in normal talk mode.
17. The power adapters are intended to be correctly oriented in a vertical or floor mount position. The prongs are not designed to hold the plug in place if it is plugged into a ceiling, under-the-table or cabinet outlet.

SAVE THESE INSTRUCTIONS

Appendix

Battery

- CAUTION: Use Only Supplied Battery.
- Do not dispose of the batteries in a fire. Check with local waste management codes for special disposal instructions.
- Do not open or mutilate the batteries. Released electrolyte is corrosive and may cause burns or injury to the eyes or skin. The electrolyte may be toxic if swallowed.
- Exercise care in handling batteries in order not to create a short circuit with conductive materials.
- Charge the batteries provided with or identified for use with this product only in accordance with the instructions and limitations specified in this manual.

Precautions for users of implanted cardiac pacemakers

Cardiac pacemakers (applies only to digital cordless telephones):

Wireless Technology Research, LLC (WTR), an independent research entity, led a multidisciplinary evaluation of the interference between portable wireless telephones and implanted cardiac pacemakers. Supported by the U.S. Food and Drug Administration, WTR recommends to physicians that:

Pacemaker patients

- Should keep wireless telephones at least six inches from the pacemaker.
- Should NOT place wireless telephones directly over the pacemaker, such as in a breast pocket, when it is turned ON.
- Should use the wireless telephone at the ear opposite the pacemaker.

WTR's evaluation did not identify any risk to bystanders with pacemakers from other persons using wireless telephones.

Operating range

This cordless telephone operates with the maximum power allowed by the Federal Communications Commission (FCC). Even so, this handset and telephone base can communicate over only a certain distance - which can vary with the locations of the telephone base and handset, the weather, and the layout of your home or office.

When the handset is out of range, the handset displays **Out of range or no pwr at base.**

If there is a call while the handset is out of range, it may not ring, or if it does ring, the call may not connect well when you press /HOME. Move closer to the telephone base, then press /HOME to answer the call.

If the handset moves out of range during a telephone conversation, there may be interference. To improve reception, move closer to the telephone base.

ECO mode

This power conserving technology reduces power consumption for optimal battery performance. The ECO mode activates automatically whenever the handset is synchronized with the telephone base.

Appendix

Maintenance

Taking care of your telephone

Your telephone contains sophisticated electronic parts, so it must be treated with care.

Avoid rough treatment

Place the handset down gently. Save the original packing materials to protect your telephone if you ever need to ship it.

Avoid water

Your telephone can be damaged if it gets wet. Do not use the handset outdoors in the rain, or handle it with wet hands. Do not install the telephone base near a sink, bathtub or shower.

Electrical storms

Electrical storms can sometimes cause power surges harmful to electronic equipment. For your own safety, take caution when using electrical appliances during storms.

Cleaning your telephone

Your telephone has a durable plastic casing that should retain its luster for many years. Clean it only with a soft cloth slightly dampened with water or mild soap. Do not use excess water or cleaning solvents of any kind.

Remember that electrical appliances can cause serious injury if used when you are wet or standing in water. If the telephone base should fall into water, **DO NOT RETRIEVE IT UNTIL YOU UNPLUG THE POWER CORD AND TELEPHONE LINE CORD FROM THE WALL.** Remove the telephone by the unplugged cords.

About cordless telephones

- **Privacy:** The same features that make a cordless telephone convenient create some limitations. Telephone calls are transmitted between the telephone base and the cordless handset by radio waves, so there is a possibility that the cordless telephone conversations could be intercepted by radio receiving equipment within range of the cordless handset. For this reason, you should not think of cordless telephone conversations as being as private as those on corded telephones.
- **Electrical power:** The telephone base of this cordless telephone must be connected to a working electrical outlet. The electrical outlet should not be controlled by a wall switch. Calls cannot be made from the cordless handset if the telephone base is unplugged, switched off or if the electrical power is interrupted.
- **Potential TV interference:** Some cordless telephones operate at frequencies that may cause interference to televisions and VCRs. To minimize or prevent such interference, do not place the telephone base of the cordless telephone near or on top of a TV or VCR. If interference is experienced, moving the cordless telephone farther away from the TV or VCR often reduces or eliminates the interference.
- **Rechargeable batteries:** Exercise care in handling batteries in order not to create a short circuit with conducting material such as rings, bracelets and keys. The battery or conductor may overheat and cause harm. Observe proper polarity between the battery and the battery charger.
- **Nickel-metal hydride rechargeable batteries:** Dispose of these batteries in a safe manner. Do not burn or puncture the battery. Like other batteries of this type, if burned or punctured, they could release caustic material which could cause injury.

Appendix

The RBRC® seal

The RBRC® seal on the nickel-metal hydride battery indicates that VTech Communications, Inc. is voluntarily participating in an industry program to collect and recycle these batteries at the end of their useful lives, when taken out of service within the United States and Canada.

The RBRC® program provides a convenient alternative to placing used nickel-metal hydride batteries into the trash or municipal waste, which may be illegal in your area.

VTech's participation in RBRC® makes it easy for you to drop off the spent battery at local retailers participating in the RBRC® program or at authorized VTech product service centers. Please call **1 (800) 8 BATTERY®** for information on Ni-MH battery recycling and disposal bans/restrictions in your area. VTech's involvement in this program is part of its commitment to protecting our environment and conserving natural resources.

RBRC® and 1 (800) 8 BATTERY® are registered trademarks of Rechargeable Battery Recycling Corporation.



Appendix

FCC, ACTA and IC regulations

FCC Part 15

This equipment has been tested and found to comply with the requirements for a Class B digital device under Part 15 of the Federal Communications Commission (FCC) rules. These requirements are intended to provide reasonable protection against harmful interference in a residential installation. This equipment generates, uses and can radiate radio frequency energy and, if not installed and used in accordance with the instructions, may cause harmful interference to radio communications. However, there is no guarantee that interference will not occur in a particular installation. If this equipment does cause harmful interference to radio or television reception, which can be determined by turning the equipment off and on, the user is encouraged to try to correct the interference by one or more of the following measures:

- Reorient or relocate the receiving antenna.
- Increase the separation between the equipment and receiver.
- Connect the equipment into an outlet on a circuit different from that to which the receiver is connected.
- Consult the dealer or an experienced radio/TV technician for help.

Changes or modifications to this equipment not expressly approved by the party responsible for compliance could void the user's authority to operate the equipment.

This device complies with Part 15 of the FCC rules. Operation is subject to the following two conditions: (1) this device may not cause harmful interference, and (2) this device must accept any interference received, including interference that may cause undesired operation. Privacy of communications may not be ensured when using this telephone.

To ensure safety of users, the FCC has established criteria for the amount of radio frequency energy that can be safely absorbed by a user or bystander according to the intended usage of the product. This product has been tested and found to comply with the FCC criteria. The handset may be safely held against the ear of the user. The telephone base shall be installed and used such that parts of the user's body other than the hands are maintained at a distance of approximately 20 cm (8 inches) or more.

This Class B digital apparatus complies with Canadian requirement:
CAN ICES-3 (B)/NMB-3(B).

FCC Part 68 and ACTA

This equipment complies with Part 68 of the FCC rules and with technical requirements adopted by the Administrative Council for Terminal Attachments (ACTA). The label on the back or bottom of this equipment contains, among other things, a product identifier in the format US:AAAEQ##TXXXX. This identifier must be provided to your telephone service provider upon request.

The plug and jack used to connect this equipment to premises wiring and the telephone network must comply with applicable Part 68 rules and technical requirements adopted by ACTA. A compliant telephone cord and modular plug is provided with this product. It is designed to be connected to a compatible modular jack that is also compliant. An RJ11 jack should normally be used for connecting to a single line and an RJ14 jack for two lines. See the installation instructions in the user's manual.

The Ringer Equivalence Number (REN) is used to determine how many devices you may connect to your telephone line and still have them ring when you are called. The REN for this product is encoded as the 6th and 7th characters following the US: in the product identifier (e.g., if ## is 03, the REN is 0.3). In most, but not all areas, the sum of all RENs should be five (5.0) or less. For more information, contact your telephone service provider.

This equipment may not be used with Party Lines. If you have specially wired alarm dialing equipment connected to your telephone line, ensure the connection of this equipment does not disable your alarm equipment. If you have questions about what will disable alarm equipment, consult your telephone service provider or a qualified installer.

If this equipment is malfunctioning, it must be unplugged from the modular jack until the problem has been corrected. Repairs to this telephone equipment can only be made by the manufacturer or its authorized agents. For repair procedures, follow the instructions outlined under the Limited warranty.

Appendix

FCC, ACTA and IC regulations

If this equipment is causing harm to the telephone network, the telephone service provider may temporarily discontinue your telephone service. The telephone service provider is required to notify you before interrupting service. If advance notice is not practical, you will be notified as soon as possible. You will be given the opportunity to correct the problem and the telephone service provider is required to inform you of your right to file a complaint with the FCC. Your telephone service provider may make changes in its facilities, equipment, operation, or procedures that could affect the proper functioning of this product. The telephone service provider is required to notify you if such changes are planned.

If this product is equipped with a corded or cordless handset, it is hearing aid compatible.

If this product has memory dialing locations, you may choose to store emergency telephone numbers (e.g., police, fire, medical) in these locations. If you do store or test emergency numbers, please:

Remain on the line and briefly explain the reason for the call before hanging up.

Perform such activities in off-peak hours, such as early morning or late evening.

Industry Canada

This device complies with Industry Canada licence-exempt RSS standard(s).

Operation is subject to the following two conditions: (1) this device may not cause harmful interference, and (2) this device must accept any interference received, including interference that may cause undesired operation.

Privacy of communications may not be ensured when using this telephone.

The term "IC:" before the certification/registration number only signifies that the Industry Canada technical specifications were met.

The Ringer Equivalence Number (REN) for this terminal equipment is 0.1. The REN is an indication of the maximum number of devices allowed to be connected to a telephone interface. The termination on an interface may consist of any combination of devices subject only to the requirement that the sum of the RENs of all the devices does not exceed five.



This product meets the applicable Industry Canada technical specifications.

Appendix

California Energy Commission battery charging testing instructions

This telephone is set up to comply with the energy-conserving standards right out of the box. These instructions are intended for California Energy Commission (CEC) compliance testing only. When the CEC battery charging testing mode is activated, all telephone functions, except battery charging, will be disabled.

To activate the CEC battery charging testing mode:

1. Unplug the telephone base power adapter from the power outlet. Make sure all handsets are plugged with charged batteries before proceeding.
2. While you press and hold /FIND HANDSET, plug the telephone base power adapter back to the power outlet.
3. After about 10 seconds, when the **IN USE** light starts flashing, immediately press /FIND HANDSET again. You must press /FIND HANDSET while the **IN USE** light is still flashing. The **IN USE** light flashes for about five seconds.

note

- When the phone successfully enters the CEC battery charging testing mode, all handsets alternately show **To register HS...** and **...see manual**.
- When the phone fails to enter this mode, repeat Step 1 through Step 3 above.

To deactivate the CEC battery charging testing mode:

1. Unplug the telephone base power adapter from the power outlet, then plug it back in. Then, the telephone base is powered up as normal.
2. Place the handset in the telephone base to register it back. The handset shows **Registering...** then **Registered** and you hear a beep when the registration process completes. This process takes about 90 seconds to complete.

note

If registration fails, the handset displays **Failed**. Repeat Step1 to 2 again.

Appendix

For C-UL compliance only

Mesures de sécurité importantes

Afin de réduire les risques d'incendie, de blessures corporelles ou d'électrocution, suivez toujours ces mesures préventives de base lorsque vous utilisez votre téléphone :

1. Lisez et comprenez bien toutes les instructions.
2. Observez toutes les instructions et mises en garde inscrites sur l'appareil.
3. Débranchez ce téléphone de la prise murale avant de le nettoyer. N'utilisez pas de nettoyeurs liquides ni en aérosol. N'utilisez qu'un chiffon doux et légèrement humecté.
4. N'utilisez pas ce produit près de l'eau, tel que près d'un bain, d'un lavabo, d'un évier de cuisine, d'un bac de lavage ou d'une piscine, ou dans un sous-sol humide ou sous la douche.
5. Ne déposez pas ce téléphone sur un chariot, support ou table chancelants. L'appareil pourrait tomber et être sérieusement endommagé.
6. Évitez d'installer le système téléphonique dans les endroits soumis à une température extrême, à la lumière directe du soleil ou à proximité immédiate d'autres appareils électriques ou électroniques. Protégez votre téléphone contre les sources d'humidité, la poussière, les vapeurs et les liquides corrosifs.
7. Le boîtier de l'appareil est doté de fentes et d'ouvertures d'aération situées à l'arrière ou en dessous. Afin d'empêcher la surchauffe, ces ouvertures ne doivent pas être obstruées en plaçant l'appareil sur un lit, divan, tapis ou autre surface similaires. Ne placez pas cet appareil à proximité d'un élément de chauffage ni d'une plinthe électrique. De plus, ne l'installez pas dans une unité murale ou un cabinet fermé qui ne possède pas d'aération adéquate.
8. Ne faites fonctionner cet appareil qu'avec le type d'alimentation indiqué sur les étiquettes de l'appareil. Si vous ne connaissez pas le voltage de votre maison, consultez votre marchand ou votre fournisseur d'électricité.
9. Ne déposez rien sur le cordon d'alimentation. Installez cet appareil dans un endroit sécuritaire, là où personne ne pourra trébucher sur la ligne d'alimentation ni le cordon téléphonique modulaire.
10. N'insérez jamais d'objets à travers les fentes et ouvertures de cet appareil, car ils pourraient toucher à des points de tension dangereux ou court-circuiter des pièces, ce qui constituerait un risque d'incendie ou d'électrocution. N'échappez pas de liquides dans l'appareil.
11. Afin de réduire les risques d'électrocution, ne démontez pas l'appareil, mais apportez-le plutôt à un centre de service qualifié s'il doit être réparé. En enlevant le couvercle, vous vous exposez à des tensions dangereuses ou autres dangers similaires. Un remontage inadéquat peut être à l'origine d'une électrocution lors d'une utilisation ultérieure de l'appareil. Débranchez l'appareil avant de procéder au nettoyage. Utilisez un chiffon humide et doux.
12. Ne surchargez pas les prises de courant et les rallonges
13. Débranchez cet appareil de la prise de courant et communiquez avec le département de service à la clientèle de VTech dans les cas suivants :
 - Lorsque le cordon d'alimentation est endommagé ou écorché.
 - Si du liquide a été échappé dans l'appareil.
 - Si l'appareil a été exposé à une source d'humidité telle que la pluie ou l'eau.
 - Si le produit ne fonctionne pas normalement en respectant les instructions de fonctionnement. Réglez uniquement les commandes indiquées dans les instructions de fonctionnement. Les réglages incorrects des autres commandes pourraient provoquer un dommage qui pourrait exiger un travail exhaustif de la part d'un technicien autorisé afin de rétablir le fonctionnement normal de l'appareil.
 - Si le produit a été échappé et que le socle et/ou le combiné a été endommagé.
 - Si le produit affiche une nette diminution de sa performance.
14. Évitez d'utiliser un téléphone (autre qu'un sans fil) pendant un orage. Les éclairs peuvent être à l'origine d'une électrocution.

Appendix

For C-UL compliance only

15. N'utilisez pas le téléphone pour rapporter une fuite de gaz à proximité de la fuite. En certaines circonstances, une flammèche pourrait être provoquée lorsque l'adaptateur est branché à une prise de courant, ou lorsque le combiné est déposé sur le socle. Ceci est un événement commun associé à la fermeture d'un circuit électrique. L'utilisateur ne devrait pas brancher le téléphone à une prise de courant, et ne devrait pas déposer le combiné chargé sur le socle, si le téléphone se trouve à proximité d'un endroit comportant des concentrations de gaz inflammables, à moins que la ventilation soit adéquate. Une flammèche dans un tel endroit pourrait provoquer un incendie ou une explosion. De tels environnements peuvent comprendre: des endroits où l'on utilise de l'oxygène médical sans ventilation adéquate; des gaz industriels (dissolvants de nettoyage, des vapeurs d'essence, etc.); une fuite de gaz naturel, etc.
16. Ne placez que le combiné de votre téléphone près de votre oreille lorsqu'en mode de conversation.
17. Ces adaptateurs ont été conçus pour être orientés en position verticale ou montés au sol. Les broches ne sont pas conçues pour maintenir l'adaptateur en place si celui-ci est branché dans une prise au plafond ou sous une table/ armoire.

CONSERVEZ CES INSTRUCTIONS

Pile

- MISE EN GARDE : N'utilisez que la pile incluse.
- Ne jetez pas la pile au feu. Vérifiez les instructions spécifiques de mise aux rebus auprès des autorités locales.
- N'ouvrez pas et ne mutilez pas la pile. L'électrolyte qui s'en échapperait est corrosif et pourrait causer des brûlures ou des blessures aux yeux ou à la peau. L'électrolyte est toxique si avalé.
- Soyez prudents lorsque vous manipulez les piles afin d'éviter les courts-circuits provoqués par des matériaux conducteurs.
- Rechargez la pile incluse avec cet appareil, selon les instructions et limites spécifiées dans ce guide d'utilisation.

Stimulateurs cardiaques implantés dans l'organisme

Les simulateurs cardiaques (s'applique uniquement aux téléphones numériques sans fil) :

L'organisme 'Wireless Technology Research, LLC (WTR)', une firme de recherche indépendante, a mené une évaluation pluridisciplinaire des interférences entre les téléphones sans fil portatifs et les stimulateurs cardiaques implantés dans l'organisme. Appuyée par l'Administration des aliments et drogues (FDA) des États-Unis, la firme WTR recommande aux médecins :

Avis aux détenteurs de stimulateurs cardiaques

- Ils doivent tenir le téléphone sans fil à une distance d'au moins six pouces du stimulateur cardiaque.
- Ils ne doivent PAS placer le téléphone sans fil directement sur le stimulateur cardiaque, tel que dans une poche de chemise, lorsque celui-ci est en marche.
- Ils doivent utiliser le téléphone sans fil en l'appuyant sur l'oreille qui se trouve dans la direction opposée au stimulateur cardiaque.

L'étude effectuée par l'organisme WRS n'a pas identifié de risque pour les détenteurs de simulateurs cardiaques causés par les gens qui utilisent un téléphone sans fil à proximité de ceux-ci.

Soin général à apporter au produit

MISE EN GARDE : Rappelez-vous que les appareils électriques peuvent causer des blessures sérieuses s'ils sont utilisés lorsque vous êtes mouillés ou lorsque vous êtes debout dans l'eau. Si le socle du téléphone tombe à l'eau, **NE LE RÉCUPÉREZ PAS AVANT D'AVOIR DÉBRANCHÉ LE CORDON D'ALIMENTATION ET LE FIL TÉLÉPHONIQUE DES PRISES MURALES**. Ensuite, récupérez-le en tenant les cordons débranchés.

Appendix

For C-UL compliance only

À propos des téléphones sans fil

- **Confidentialité** : Les mêmes caractéristiques qui constituent des avantages pour les téléphones sans fil affichent également des restrictions. Les appels téléphoniques sont transmis entre le combiné sans fil et le socle par le biais d'ondes radio ; il y a donc la possibilité que vos conversations téléphoniques sans fil soient interceptées par des équipements de réception radio se trouvant dans la portée du combiné sans fil. Pour cette raison, vous ne devez pas percevoir les communications téléphoniques sans fil comme étant aussi confidentielles que celles des téléphones à cordons.
- **Alimentation électrique** : Le socle de ce téléphone sans fil doit être branché à une prise électrique fonctionnelle. La prise électrique ne doit pas être contrôlée par un interrupteur mural. Les appels ne pourront pas être effectués du combiné sans fil si le socle est débranché ou mis hors tension ou si le courant est coupé.
- **Possibilité d'interférences aux téléviseurs** : Certains téléphones sans fil fonctionnent sur des fréquences pouvant causer des interférences aux téléviseurs et aux magnétoscopes. Pour réduire ou prévenir de telles interférences, ne placez pas le socle du téléphone sans fil près ou sur un téléviseur ou magnétoscope. S'il y a présence de parasites, il est conseillé d'éloigner le téléphone sans fil du téléviseur ou du magnétoscope afin de réduire possiblement les interférences.
- **Piles rechargeables** : Manipulez les piles avec soin afin de ne pas les court-circuiter avec des bagues, bracelets ou clés. Les piles ou le conducteur peut surchauffer et causer des blessures. Respectez la polarité adéquate entre la pile et le chargeur.
- **Les bloc-piles rechargeables à l'hydrure métallique de nickel** : Jetez ces blocs-piles de manière écologique et sécuritaire. Ne les incinerez pas et ne les percez pas. Tel que les autres piles de ce type, elles pourraient dégager une matière toxique qui peut causer des blessures corporelles si elles sont brûlées ou percées.

Appendix

Limited warranty

What does this limited warranty cover?

The manufacturer of this VTech Product warrants to the holder of a valid proof of purchase (“Consumer” or “you”) that the Product and all accessories provided in the sales package (“Product”) are free from defects in material and workmanship, pursuant to the following terms and conditions, when installed and used normally and in accordance with the Product operating instructions. This limited warranty extends only to the Consumer for Products purchased and used in the United States of America and Canada.

What will VTech do if the Product is not free from defects in materials and workmanship during the limited warranty period (“Materially Defective Product”)?

During the limited warranty period, VTech’s authorized service representative will repair or replace at VTech’s option, without charge, a Materially Defective Product. If we repair the Product, we may use new or refurbished replacement parts. If we choose to replace the Product, we may replace it with a new or refurbished Product of the same or similar design. We will retain defective parts, modules, or equipment. Repair or replacement of the Product, at VTech’s option, is your exclusive remedy. VTech will return the repaired or replacement Products to you in working condition. You should expect the repair or replacement to take approximately 30 days.

How long is the limited warranty period?

The limited warranty period for the Product extends for ONE (1) YEAR from the date of purchase. If VTech repairs or replaces a Materially Defective Product under the terms of this limited warranty, this limited warranty also applies to the repaired or replacement Product for a period of either (a) 90 days from the date the repaired or replacement Product is shipped to you or (b) the time remaining on the original one-year warranty; whichever is longer.

What is not covered by this limited warranty?

This limited warranty does not cover:

1. Product that has been subjected to misuse, accident, shipping or other physical damage, improper installation, abnormal operation or handling, neglect, inundation, fire, water or other liquid intrusion; or
2. Product that has been damaged due to repair, alteration or modification by anyone other than an authorized service representative of VTech; or
3. Product to the extent that the problem experienced is caused by signal conditions, network reliability, or cable or antenna systems; or
4. Product to the extent that the problem is caused by use with non-VTech accessories; or
5. Product whose warranty/quality stickers, product serial number plates or electronic serial numbers have been removed, altered or rendered illegible; or
6. Product purchased, used, serviced, or shipped for repair from outside the United States of America or Canada, or used for commercial or institutional purposes (including but not limited to Products used for rental purposes); or
7. Product returned without a valid proof of purchase (see item 2 on the next page); or
8. Charges for installation or set up, adjustment of customer controls, and installation or repair of systems outside the unit.

Appendix

Limited warranty

How do you get warranty service?

To obtain warranty service in the United States of America, please visit our website at www.vtechphones.com or call 1 (800) 595-9511. In Canada, go to www.vtechcanada.com or dial 1 (800) 267-7377.

NOTE: Before calling for service, please review the user's manual - a check of the Product's controls and features may save you a service call.

Except as provided by applicable law, you assume the risk of loss or damage during transit and transportation and are responsible for delivery or handling charges incurred in the transport of the Product(s) to the service location. VTech will return repaired or replaced Product under this limited warranty. Transportation, delivery or handling charges are prepaid. VTech assumes no risk for damage or loss of the Product in transit. If the Product failure is not covered by this limited warranty, or proof of purchase does not meet the terms of this limited warranty, VTech will notify you and will request that you authorize the cost of repair prior to any further repair activity. You must pay for the cost of repair and return shipping costs for the repair of Products that are not covered by this limited warranty.

What must you return with the Product to get warranty service?

1. Return the entire original package and contents including the Product to the VTech service location along with a description of the malfunction or difficulty; and
2. Include a "valid proof of purchase" (sales receipt) identifying the Product purchased (Product model) and the date of purchase or receipt; and
3. Provide your name, complete and correct mailing address, and telephone number.

Other limitations

This warranty is the complete and exclusive agreement between you and VTech. It supersedes all other written or oral communications related to this Product. VTech provides no other warranties for this Product. The warranty exclusively describes all of VTech's responsibilities regarding the Product. There are no other express warranties. No one is authorized to make modifications to this limited warranty and you should not rely on any such modification.

State/Provincial Law Rights: This warranty gives you specific legal rights, and you may also have other rights, which vary from state to state or province to province.

Limitations: Implied warranties, including those of fitness for a particular purpose and merchantability (an unwritten warranty that the Product is fit for ordinary use) are limited to one year from the date of purchase. Some states/provinces do not allow limitations on how long an implied warranty lasts, so the above limitation may not apply to you. In no event shall VTech be liable for any indirect, special, incidental, consequential, or similar damages (including, but not limited to lost profits or revenue, inability to use the Product or other associated equipment, the cost of substitute equipment, and claims by third parties) resulting from the use of this Product. Some states/provinces do not allow the exclusion or limitation of incidental or consequential damages, so the above limitation or exclusion may not apply to you.

Please retain your original sales receipt as proof of purchase.

Appendix

Technical specifications

Transmit frequency	Handset: 1921.536-1928.448 MHz Telephone base: 1921.536-1928.448 MHz
Channels	5
Nominal effective range	Maximum power allowed by FCC and IC. Actual operating range may vary according to the environmental conditions at the time of use.
Power requirements	Handset: 2.4V Ni-MH battery Telephone base: 6V DC @ 400mA Charger: 6V AC @ 300mA
Memory	Handset directory: 200 memory locations; up to 30 digits and 15 characters Handset caller ID log: 50 memory locations; up to 24 digits and 15 characters

Index

A

About cordless telephones 65
Add a cell phone 15
Add a directory entry 36–37
Alphabetical search 38
Answer a call 26, 27, 28

B

Base layout 9
Battery 3, 4, 64
Bluetooth glossary 14
Bluetooth setup 15

C

Call transfer 33
Call waiting 26, 28
Caller ID log 44
Caller ID log messages 48
Cell phone - download directory 17
Chain dialing 31
Charging 4
Clock 21
Connect a paired cell phone 16

D

Date and time 21
Delete a caller ID log entry 48
Delete a directory entry 40
Dial a caller ID log entry 47
Dial a directory entry 39
Dialing options 46
Dial mode 25
Directory 17, 35–42
Download directory 17
DSL filter 2

E

ECO mode 64
Edit a directory entry 39
End a call 26, 28
Expand your telephone system 53

F

FCC, ACTA and IC regulations 67–68
Find handset 32
Flash 26

G

Glossary 14

H

Handset battery charging 4
Handset battery installation 3
Handset icons 52
Handset layout 10–11
Handset lights 51
Handset locator 32
Home area code 24

I

Icons 52
Important safety instructions 63
Installation 2, 5–7
Installation (battery) 3
Installation (telephone base) 2
Intercom 34

J

Join a call 33

K

Key tone 24

L

Language 22
Layout 9–11
Lights 51
Limited warranty 73–74

M

Maintenance 65
Make a call 26, 27
Menu 18
Missed call indicator 45
Mute 29

O

Operating range 64

P

Pair and connect a cell phone 15
Parts checklist 1
PIN 14, 15
Precautions for users of implanted cardiac pacemakers 64
Predial 26, 27

Q

Quiet mode 20

Index

R

- Redial 30
- Review the caller ID log 45
- Ringer tone 19
- Ringer volume 19

S

- Safety instructions 63
- Save a caller ID log entry 47
- Screen messages 48, 49–50
- Share a call 33
- Speakerphone 26, 27, 29

T

- Tabletop 7
- Technical specifications 75
- Telephone base layout 9
- Telephone base lights 51
- Temporary ringer silencing 30
- Temporary tone dialing 31
- Transfer a call 33
- Troubleshooting 54–62

U

- Using the menu 18

V

- Voicemail 22, 23, 28
- Voicemail indicators 23
- Volume 19, 29

W

- Wall mount 5–6
- Warranty 73–74
- Website 25



Designed to fit your home.
And your life.

VTech Communications, Inc.
A member of THE VTECH GROUP OF COMPANIES.
VTech is a registered trademark of VTech Holdings Limited.
Specifications are subject to change without notice.
© 2014 VTech Communications, Inc.
All rights reserved. 12/14. DS6511-X_WEBICIB_V10.0
Document order number: 91-006047-030-100

